

Operating Manual Leg- and Arm Lift

2-2017



ISO 13485
Management System Certification

BUREAU VERITAS
Certification Denmark A/S



Content

1. Introduction.....	3
2. Unpacking	3
3. General Security Rules.....	4
4. Area of Use	5
5. Products Life expectancy	5
6. Equipment and Accessories	5
7. Power connection	6
8. Battery charging	6
9. Electrical operating procedure.....	7
10. Manual operating procedure.....	8
11. Technical specifications.....	8
12. Handling of parts during Transport	9
13. Cleaning	9
14. Maintenance	9
15. Service	10
16. Transport and storage	10
17. Disposal.....	11
18. Electromagnetic – EMC effects	11
19. Guarantee	12
20. Symbol explanation	13
Annex A Periodic inspection.....	14
Annex B Daily inspection before use	15
Annex C Recommended annual service inspection	16
Annex D Drawings.....	18
Annex E Spare parts list.....	19
Annex F Troubleshooting	20

Operating Manual Leg- and Arm Lift

2-2017

1. Introduction

Congratulations with your new Rehab-Care dk ApS equipment.
Rehab-Care dk ApS products are modern and up-to-date, based on our long experience in this field.
This equipment brings functionality, quality and easy handling to an optimal level.
Through continuous development at all levels of our manufacturing process, we are committed to pay attention to details and quality. We are therefore your guarantee of a very reliable and functional product.

The Leg- and Arm Lift complies with the medical directives for 1 class equipment (MDD 93/42EEC), EN 60601-1, EN60601-1-2, IEC60601-2-52.

Thank you for your confidence in our product, and for your cooperation.
We wish you every satisfaction with your new equipment.

Best regards Rehab-Care dk ApS.

Version 02-17.01.2017

Manufactured by:



Rehab- Care.dk ApS
Avnvej 10
7400 Herning, DK













Agent:

2. Unpacking

Unpack the lift carefully and check all parts and accessories.
Check for possible transport damage.
We recommend that the lift is cleaned before use, see cleaning instructions.

Contact dealer if the equipment is damaged or not functioning.

3. General Security Rules

-  Warning! Do not use a high pressure cleaner on this product.
-  Warning! Do not use chemicals that are not improve. Carry out an annual inspection for damage.
-  Warning! Use only the supplied remote control.
-  Warning! Prevent foreign articles from damaging the wheels.
-  Warning! Use only spare wheels recommended by the supplier.
-  Warning! The lift has a maximum capacity of 100 kg SWL.
-  Warning! The lift should not be used if there is any doubt about it being in good working order.
-  Warning! The lift is not approved for private use.
-  Warning! Wrong use of cables, power supply, and remote control can lead to accidents.
-  Warning! Prevent damage to power cable.
-  Warning! Use of non-approved accessories may result in loss of CE approval.
-  Warning! Attention must be paid when changing the position of the bed guard.

Read all instructions carefully before use.

4. Area of Use

The lift is used for disinfection before surgeries in hospitals.

The lift is for indoor use only.

The lift safe working load (SWL) is as follows:

SWL: 100 kg.

Persons with physical or psychological handicaps must not use the product without supervision or without adequate training in the use of the lift.

Children must not be left unsupervised around the lift, it is not a toy.



Warning! Lift is not tested and evaluated in relation to use in private homes, therefore do not use product in private homes

5. Products Life expectancy

The product has a life expectancy of 10 years.

Life expectancy is based on the correct use, cleaning, service and maintenance.

If the lift is to be used longer than the above-mentioned life expectancy, it must be evaluated by qualified service personnel before further use.

It is the users' responsibility to evaluate the lift maintains, if used over the listed life time.

Electrical parts must only be serviced by qualified technicians.

6. Equipment and Accessories

The lift consists of:

- Frame on 4 wheels. Individual lock.
- Electrical remote control
- Battery charger

Extra accessories available:

- Stainless steel shackle for lifting two legs (double lifting)

7. Power connection

The lift is connected to 230V by plugging the transformer into the power supply.

The lift does not have to be connected 230V for use as the lift is equipped with battery.

When the charger is not in use, the cord is wrap up and stored in a dry and safe place.



Warning! Before connection, control the cable for damage



8. Battery charging

The battery box should be charged before use to ensure the longest possible life of the battery. Charging time depends on the condition of the battery.

Before the lift is used for the first time, the battery should be charged for **24 hours**.

The lift is charged by connecting the plug / transformer to the remote control and then the power plug is connected to the power supply 230 V.

The transformer has an indicator on the front for show of status:

Red: The lift is charging.

Green: The lift is fully charged.



Operating Manual Leg- and Arm Lift





2-2017



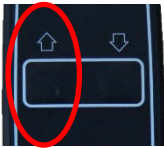

9. Electrical operating procedure

Adjustment of the lift is by use of the remote control.

See diagram on the remote control.

The lift can be operated by both caretaker and patient.

		
		
	The Leg- and arm lift is elevated	The Leg- and arm lift is lowered



-  When lifting a patient, the maximum weight must not be exceeded
-  When lifting, SWL must not be exceeded
-  Check there is a free space over the lift before lifting
-  The lift must be able to function unhindered up and down
-  Check the remote control cable is in good condition and free from any damage

Operating Manual

Leg- and Arm Lift

2-2017

10. Manual operating procedure

Wheel 	The wheels can be locked by placing the pedal (red) over the wheel
Pushing handle 	The lift is moved by using the pushing handle



Warning!

Avoid making a crooked lift with Leg- and Arm Lift, as this can cause the lift tipping over. This is prevented by whatever is lifted hangs vertically down from the forearm in a strap. Note that it may be necessary to reposition lift.

11. Technical specifications

11.1 Weights and Measures

Length	1000mm
Width	600mm
Height	1365-2110mm
Lifting height	750mm
Weight	30,5 kg
Power requirements	230V~50Hz
Ingress protection	IP50
Max load	100kg
Battery type	NiMH 24V DC, 1400mAh

12. Handling of parts during Transport

There are no loose parts.

13. Cleaning

The lift should be cleaned with a brush or sponge, using a cleaning or disinfection liquid. Rinse well with clean water and then dry thoroughly.

100% chlorine solution must not be used.

Wheels should only be cleaned with a non-corrosive cleaner.



Warning

Never use a high pressure cleaner on the product



Warning

Steam cleaning must not be used



Warning

Automatic washing machines must not be used

14. Maintenance

Wheels should be kept free of hair and dirt.

Annual service is recommended.

Moving parts should be checked, tightened and greased.

Worn bearings should be replaced, at turning points.

Batteries should be replaced as necessary.

Operating Manual

Leg- and Arm Lift

2-2017

15. Service

It is recommended that qualified personnel are servicing the lift once a year. It is the responsibility of the owner to ensure the service is carried out. A service protocol for the lift should be established. The protocol should be signed by the customer after each service. If the technician discovers a serious defect with the lift, he is under obligation to remove the lift if the defect could lead to a security risk.

Service, repairs and other work on the lift between service checks should be noted in the service protocol.

15.1 Service - Actuator

The actuator/motor should be replaced after 11.000 cycles or min. every 5 years. Replacement of actuator must only be carried out by authorized service personnel.

15.2 Service - Wheels

Wheels should be serviced when necessary: Tightening of bolts.

Dust-tight bearings require no lubrication.

Use only corrosion-free cleaning liquid.

Wheels and parts must be replaced as soon as a malfunction is detected.

15.3 Service - Battery

If the lift is not functioning normally and the batteries are fully charged, it could be that the lifetime of the battery has been exceeded and the battery should therefore be replaced.

Replacement of the battery must be carried out by qualified personnel.

Use only original spare parts.

16. Transport and storage

If the lift is not to be used for a long period, it is recommended that it be covered to protect it from dirt and dust. The battery should also be removed, as the lifetime of the battery is significantly reduced if fully discharged.

The lift should be stored in a frost-free environment with humidity of not exceeding 80%.

Transport and storage requirements:

- Humidity between 10 and 80%
- Temperature between -30 and 40 deg. C
- Pressure between 700 – 1100 hPa

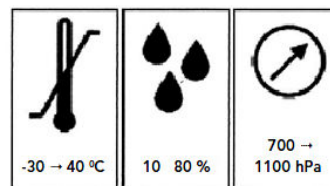

17. Disposal

The lift should be separated into electronic and metal waste and should not be disposed to normal waste.

18. Electromagnetic – EMC effects

Mobile RF communication equipment (for example cell phones) can affect electrical medical equipment.

Use of other than the authorized accessories and cables could result in increased emission or reduce product immunity.

Power supply via grid-power must be as normally used in hospital environment.

19. Guarantee

In accordance with Danish law, the lift has a 2-year guarantee.

The guarantee becomes null and void in the following circumstances:

1. Overloading the lift.
2. Violent use of lift.
3. Operating error, wrong use of lift.
4. Lack of or wrong maintenance.
5. If the LINAK electrical parts are opened or have been wrongly used.

For complaints: Please provide serial number. This can be found on the product label, located at the wheel frame.



At Rehab-Care dk ApS we endeavor to continually improve our products.

We reserve the right to improve the product without prior notice.

All measurements on drawings or other material are only guidelines with the usual provisions for errors.

20. Symbol explanation

The following symbols are used on labels or in this Manual:



Warning, see attached document



User information

IPX4 CBJ Protection against water damage to enclosed parts

IPX6 CB12 Protection against jets of water (12.5 mm jet) to enclosed parts



Class 2 equipment



Type B equipment (EN 60601-1)



For indoor use



CE approval directive for medical equipment 93/42/EC

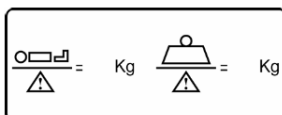
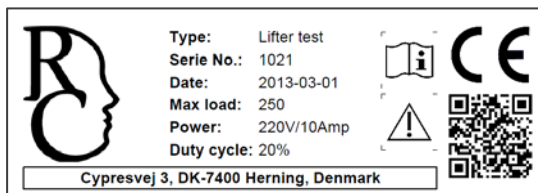

Safe Working Load (SWL)
Patient Max. Weight.

Annex A Periodic inspection

A.1 Periodic inspections should be carried out according to the time frame recommended by the manufacturer, or at least once a year. The periodic inspection comprises a visual inspection, especially of the wheelbase structure, hoist mechanism, brakes, turning points, security devices and patient aids, as well as a function test and normal maintenance, e.g. brake adjustment, tightening of screws, etc.

Each inspection must include one (1) lift with maximum load.

A.2 Periodic inspection must be carried out by a suitably qualified person with knowledge of the construction, use and maintenance of the equipment.

A.3 All-important security observations must be entered in a logbook to be kept by the person(s) responsible for servicing/maintenance of the lift.

The date measures are taken in reaction to the observations should also be noted in the logbook.

A.4 Date and result of the inspection should be entered in the logbook and signed by the inspector.

A.5 In case of fault, wear or other damage that threatens the security of the lift, the owner should be informed immediately. In the case of evident security risk, the lift should be withdrawn from use immediately. The lift must not be used until the fault is rectified.

A.6 Any damage threatening security of the lift that occurs between inspections and which has already been corrected should be entered in the logbook.

A.7 Faults and damage should be reported to the manufacturer/dealer. This feedback must be entered in the logbook. Annex A

Operating Manual

Leg- and Arm Lift

2-2017

Annex B Daily inspection before use

Nr.	Check	Remarks
1	<ul style="list-style-type: none">All parts in place, no loose parts	
2	<ul style="list-style-type: none">No electrical defects, actuator, cables	
3	<ul style="list-style-type: none">No abnormal noise from actuator or control box	
4	<ul style="list-style-type: none">No rust or surface damage	
5	<ul style="list-style-type: none">No visual or other damage	
6	<ul style="list-style-type: none">Wheel and brake function	
7	<ul style="list-style-type: none">Check bolts and mounted parts are properly fixed on lift as well as accessories, in order to prevent undue slackness and spaces	

Daily cleaning

Remove hair and dust around the wheels.

Clean lift with a damp cloth.

Clarification:

The lift should be cleaned with cleaning or disinfection liquid, using a brush or sponge, and thereafter washed. Dry thoroughly after wash.

Concentrated disinfection liquid must not be used.

100% chlorine solution must not be used.

Automatic wash machines must not be used.

For cleaning of wheels, corrosion-free liquid must be used.



Warning!
High pressure cleaner must not be used



Warning!
Steam cleaning must not be used



Warning!
Machine wash must not be used

Operating Manual Leg- and Arm Lift

2-2017

Annex C Recommended annual service inspection

Date:		Product ID/serial no.:
Carried out by:		
Service at:		

No.	Check	Remarks
	Visual check of product	
1	- wear	
2	- distortion	
3	- general damage	
4	- rust	
5	- stability no loose parts	
6	- wheels running easily	
7	- wheel lock functioning	
8	- check remote control	
	Lift motor/actuator	
9	- raise lift to maximum to ensure it stops	
10	- actuator/lift motor to be replaced after 11.000 cycles or min. every 5 years	
11	Check all functions with normal use (full load, complete cycle)	

Operating Manual Leg- and Arm Lift

2-2017

	Electrical parts/connections	
12	Check all cables for wear	
13	Check all cables to ensure they will not be damaged during use	
14	Check all cables are free of damage	
15	Check all electrical parts are equipped with readable labels.	
16	Check battery and control boxes for wear and tear	
	Other	
17	Clean and lubricate as necessary	
18	Label with date of next inspection	
19		
20		

Date: _____ Initials/signature: _____

**The yearly inspection can be electronically registered in the service logbook at Rehab-Care dk ApS.
Contact Rehab-Care dk ApS for further information.**

Operating Manual Leg- and Arm Lift

2-2017

Annex D Drawings

D1.Drawing – Leg- and arm Lift

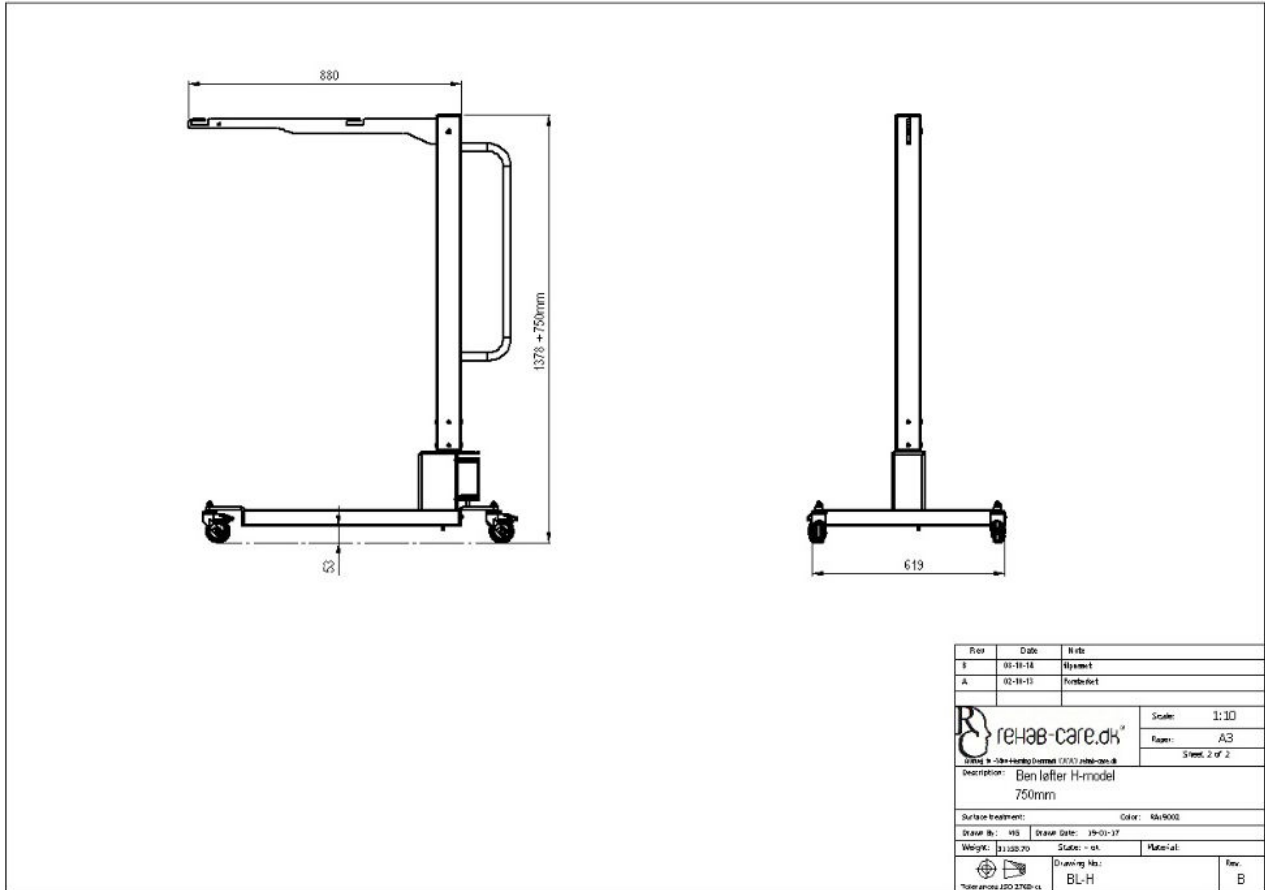

Operating Manual Leg- and Arm Lift

2-2017

Annex E Spare parts list

ITEM NO.	PART NUMBER	Description	QTY.
1	BL-H-1000	Benlæfter underdel	1
2	BL-H-2000	Arm for benlæfter	1
3	BL-2-1008	Glide skinne POM	4
4	80X80 PRO-P		1
5	SO-10642 - M5 X 10 - - 10N		8
6	SO-10642 - M6 X 8 - - 8N		2
7	BL-2-1018	Top bolt for benlæfter	1
8	BL-2-1020	Glide skinne yderløber POM	4
9	SO-7380 - M5 X 10 - - 10N		8
10	SO-7380 - M8 X 10 - - 10N		1
11	628-760		1
12	BE-7001	Støtteklods for LA28	1
13	BA1-12		1
14	SO-4762 M10 X 50 - - 12N		1
15	SO-7045 - M5 X 12 - - 12N		4
16	S70-10x15	Gevind tap for hjul	4
17	5326 PJP 075 L51-10	Hjul med bremse ø75	4
18	DN11587 - M10 - - NNU		5

Rev	Date	Info
3	05-10-18	NYT skit
A	05-10-13	NYT skit

reHAB-care.dk

 Description: Benlæfter H-model

 750mm

 Scale: 1:8

 Paper: A3

 Sheet: 1 of 2

Surface treatment:	Color:
PO	RAL9000

Weight:	Scale:	Material:
11.000 kg	ca.	st.

Drawing No.:	Rev.:
BL-H	B

Operating Manual

Leg- and Arm Lift

2-2017

Annex F Troubleshooting

No.	Fault	Possible cause	Solution
1	Malfunction	Is power plug on?	Switch on
2	Malfunction	Are all plugs pressed firmly in?	Press plug in firmly
3	Malfunction	Is there visible damage to cable?	Replace cable
4	Malfunction	Battery	Replace with fully charged battery

Contact dealer if the lift is not functioning correctly.

A defect lift must not be used.