

Operating Manual

3-part Treatment Couch



Operating Manual

3-part Treatment Couch

Content

1. Introduction.....	3
2. Unpacking	3
3. General Security Rules.....	4
4. Area of Use	5
5. Products Life expectancy	5
6. Equipment and Accessories	5
7. Power connection	6
8. Battery charging (accessories)	6
9. Electrical operating procedure.....	7
10. Manual operating procedure.....	8
11. Trendelenburg (accessory).....	9
12. Technical specifications.....	9
13. Handling of parts during Transport	9
14. Cleaning	9
15. Maintenance.....	10
16. Service	10
17. Transport and storage	11
18. Disposal.....	11
19. Electromagnetic – EMC effects	11
20. Guarantee	12
21. Symbol explanation	13
Annex A Periodic inspection.....	14
Annex B Daily inspection before use.....	15
Annex C Recommended annual service inspection	16
Annex D Drawings.....	18
Annex E Spare parts list.....	19
Annex F Troubleshooting	20
Appendix Battery	21

Operating Manual

3-part Treatment Couch

1. Introduction

Congratulations with your new Rehab Care DK ApS equipment.
Rehab Care DK ApS products are modern and up to date, based on our long experience in this field.
This equipment brings functionality, quality and easy handling to an optimal level.
Through continuous development at all levels of our manufacturing process, we are committed to pay attention to details and quality. We are therefore your guarantee of a very reliable and functional product.

The Couch complies with the MDR, classes 1 products (Medical Devices Regulation (EU) 2017/745 - MDR), EN60601-1, EN60601-1-2, IEC21856:2022.
Thank you for your confidence in our product, and for your cooperation.
We wish you every satisfaction with your new equipment.

Best regards Rehab Care DK ApS.

Version 05-09 2024

Manufactured by:



Rehab Care DK ApS
Avnvej 10
7400 Herning, DK

Agent:

2. Unpacking

















Unpack the couch carefully and check all parts and accessories.
Check for possible transport damage.
We recommend that the couch is cleaned before use, see cleaning instructions.

Contact dealer if the equipment is damaged or not functioning.

Operating Manual

3-part Treatment Couch

3. General Security Rules

-  Warning! Do not use a high-pressure cleaner on this product.
-  Warning! Do not use chemicals that are not improve. Carry out an annual inspection for damage.
-  Warning! Use only the supplied remote control.
-  Warning! Prevent foreign articles from damaging the wheels.
-  Warning! Use only spare wheels recommended by the supplier.
-  Warning! The couch must not be operated by children under the age of 12.
-  Warning! The couch has a maximum capacity of 250 kg SWL.
-  Warning! Use only approved mattresses of the same type as those supplied.
-  Warning! The couch should not be used if there is any doubt about it being in good working order.
-  Warning! The couch is not approved for private use.
-  Warning! When the patient is not being supervised, the couch should be in the lowest position to prevent falling accidents.
-  Warning! Wrong use of cables, power supply, and remote control can lead to accidents.
-  Warning! Prevent damage to power cable.
-  Warning! Couches must not be stacked on top of one another.
-  Warning! Use of non-approved accessories may result in loss of CE approval.
-  Warning! Attention must be paid when changing the position of the bed guard.
-  Warning! Use of the Trendelenburg function must only be in accordance with the hospital's internal security rules.

Read all instructions carefully before use.

Operating Manual

3-part Treatment Couch

4. Area of Use

The couch is for use in out-patient clinics, casualty wards and doctor's surgeries.

The couch is for indoor use only.

The couches safe working load (SWL) is as follows:

SWL:	250 kg.
Patient:	180 kg.
Mattress:	10 kg.
Accessories:	60 kg.

Persons with physical or psychological handicaps must not use the product without supervision or without adequate training in the use of the couch.

Children must not be left unsupervised around the couch; it is not a toy.



Warning! Couch is not tested and evaluated in relation to use in private homes, therefore, do not use product in private homes



Warning! Couch should not be used by children under the age of 12

5. Products Life expectancy

The product has a life expectancy of 10 years.

Life expectancy is based on the correct use, cleaning, service and maintenance.

If the couch is to be used longer than the above-mentioned life expectancy, it must be evaluated by qualified service personnel before further use.

It is the users' responsibility to evaluate the couch maintains, if used over the listed lift time.

Electrical parts must only be serviced by qualified technicians.

6. Equipment and Accessories

The couch consists of:

- Wheel-based undercarriage with 3-part treatment surface
- Electrical remote controlled elevation function

Extra accessories available:

- Foot control for 1 or 2 functions.
- Electric adjustment of back and seat position.
- Trendelenburg and reverse Trendelenburg adjustments.
- 3-part neck piece - head with armrests on both sides.
- Bed guard.
- Accessories rails.
- Paper Holder.

Operating Manual

3-part Treatment Couch

7. Power connection

Plug main cable into power supply.

The couch is equipped with a 230V/DC transformer.

Roll up cable when charger is not in use.



Warning! Before connection, control the cable for damage



Warning! Remove cable from main switch to disconnect power supply



8. Battery charging (accessories)

The battery box should be charged before use to ensure the longest possible life of the battery. Charging time depends on the condition of the battery.

Before the couch is used for the first time, the battery should be charged for **24 hours**.

Thereafter battery charging time will be **4 hours**.



Operating Manual



3-part Treatment Couch





9. Electrical operating procedure

Adjustment of the couch is by use of the remote control.

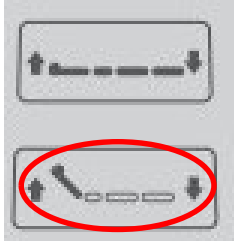
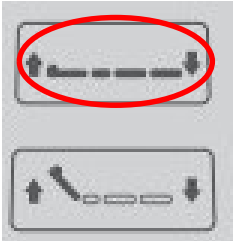
See diagram on the remote control.

The couch can be operated by both caretaker and patient.





		
		
	<p>1. Head part is lifted 2. Head part is lowered</p>	<p>1. Lying surface is elevated 2. Lying surface is lowered</p>

-  When lifting with a patient, the maximum weight must not be exceeded
-  When lifting, SWL must not be exceeded
-  Check there is a free space over the couch before lifting
-  The couch must be able to function unhindered up and down
-  Check the remote-control cable is in good condition and free from any damage

Operating Manual

3-part Treatment Couch

10. Manual operating procedure

<p>Wheel lock (pedal)</p> 	<p>No-lock function</p> <p>Brake pedal in horizontal position – no lock function</p> <p>NOTE: To move the couch, brake pedal should be in horizontal position</p>
<p>Wheel lock (pedal)</p> 	<p>Lock function</p> <p>Brake pedal (red end down) couch is locked against rolling and turning</p>
<p>Wheel steering (pedal)</p> 	<p>Steering activated</p> <p>Brake pedal (green end down) activates steering function (under transport)</p>
<p>Bed rail (accessory)</p> 	<p>Bed guard can be in two positions: up or down.</p> <p>The locking device is pressed down, bed guard can be folded down.</p> <p>When bed guard is folded down it will be under the height of the mattress</p> <p> By changing positions, it may be a risk of pinching fingers.</p>

Operating Manual

3-part Treatment Couch

11. Trendelenburg (accessory)

The couch can be adjusted in Trendelenburg (12-degree angle) by releasing the lock / pulling up the handle on the right and left side of the couch at the foot end.



Warning!

Use of the Trendelenburg function must only be used in accordance with the hospital's internal security regulations



12. Technical specifications

12.1 Choice of mattress:

The mattress is attached to the couch.

12.2 Angles and heights:

Angles and heights are given under point **D.1 Couch diagram**.

13. Handling of parts during Transport

There are no loose parts.

14. Cleaning

The couch should be cleaned with a brush or sponge, using a cleaning or disinfection liquid. Rinse well with clean water and then dry thoroughly.

100% chlorine solution must not be used.

Wheels should only be cleaned with a non-corrosive cleaner.

The mattress should be cleaned with a damp cloth and soap/cleaning liquid.



Warning

Never use a high-pressure cleaner on the product



Warning

Steam cleaning must not be used



Warning

Automatic washing machines must not be used

Operating Manual

3-part Treatment Couch

15. Maintenance

Wheels should be kept free of hair and dirt.

Annual service is recommended.

Moving parts should be checked, tightened and greased.

Worn bearings should be replaced, at turning points.

Batteries should be replaced as necessary.

16. Service

It is recommended that qualified personnel are servicing the couch once a year. It is the responsibility of the owner to ensure the service is carried out. A service protocol for the couch should be established. The protocol should be signed by the customer after each service. If the technician discovers a serious defect with the couch, he is under obligation to remove the couch if the defect could lead to a security risk.

Service, repairs and other work on the couch between service checks should be noted in the service protocol.

16.1 Service - Actuator

The actuator/motor should be replaced after 11.000 cycles.

Replacement of actuator must only be carried out by authorized service personnel.

16.2 Service - Wheels

Wheels should be serviced when necessary: Tightening of bolts.

Dust-tight bearings require no lubrication.

Use only corrosion-free cleaning liquid.

Wheels and parts must be replaced as soon as a malfunction is detected.

16.3 Service - Battery

If the couch is not functioning normally and the batteries are fully charged, it could be that the lifetime of the battery has been exceeded and the battery should therefore be replaced.

Replacement of the battery must be carried out by qualified personnel.

Use only original spare parts.

Operating Manual

3-part Treatment Couch

17. Transport and storage

If the couch is not to be used for a long period, it is recommended that it be covered to protect it from dirt and dust. The battery should also be removed, as the lifetime of the battery is significantly reduced if fully discharged.

The couch should be stored in a frost-free environment with humidity of not exceeding 80%.

Transport and storage requirements:

- Humidity between 10 and 80%
- Temperature between -30 and 40 deg. C
- Pressure between 700 – 1100 hPa

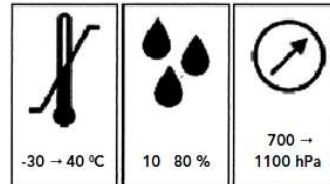

18. Disposal

The couch should be separated into electronic, metal and the mattress waste and should not be disposed to normal waste.

19. Electromagnetic – EMC effects

Mobile RF communication equipment (for example cell phones) can affect electrical medical equipment.

Use of other than the authorized accessories and cables could result in increased emission or reduce product immunity.

Power supply via grid-power must be as normally used in hospital environment.

Operating Manual

3-part Treatment Couch

20. Guarantee

In accordance with Danish law, the couch has a 2-year guarantee.

The guarantee becomes null and void in the following circumstances:

1. Overloading the couch.
2. Violent use of couch.
3. Operating error, wrong use of couch.
4. Lack of or wrong maintenance.
5. If the LINAK electrical parts are opened or have been wrongly used.

At Rehab-Care dk ApS we endeavor to continually improve our products.

We reserve the right to improve the product without prior notice.

All measurements on drawings or other material are only guidelines with the usual provisions for errors.

Operating Manual

3-part Treatment Couch

21. Symbol explanation

The following symbols are used on labels or in this Manual:



Warning, see attached document.



User information



Class 2 equipment



Type B equipment (EN 60601-1)



For indoor use



Medical Equipment.



CE approval MDR (Medical Device Regulation) 2017/745



Safe Working Load (SWL) = Patient Max. Weight. + equipment



production address.



Production date.



Product item no.



Product serial no.



unique equipment identifier.

Product label. (example).

Rehab Care
Avnvej 10
7400 Herning
Danmark

29-07-2024

REF AKUT-14000

MAX LOAD:
250 kg

POWER:
230V/24V5Amp

DUTY CYCLE:
10 %

MANUAL

UDI 10013

SN 10013

(01)05745000344130(11)240729(10)1005(21)10013

Operating Manual

3-part Treatment Couch

Annex A Periodic inspection

A.1 Periodic inspections should be carried out according to the time frame recommended by the manufacturer, or at least once a year. The periodic inspection comprises a visual inspection, especially of the wheelbase structure, hoist mechanism, brakes, turning points, security devices and patient aids, as well as a function test and normal maintenance, e.g. brake adjustment, tightening of screws, etc.

Each inspection must include one (1) lift with maximum load.

A.2 Periodic inspection must be carried out by a suitably qualified person with knowledge of the construction, use and maintenance of the equipment.

A.3 All-important security observations must be entered in a logbook to be kept by the person(s) responsible for servicing/maintenance of the couch.

The date measures are taken in reaction to the observations should also be noted in the logbook.

A.4 Date and result of the inspection should be entered in the logbook and signed by the inspector.

A.5 In case of fault, wear or other damage that threatens the security of the couch, the owner should be informed immediately. In the case of evident security risk, the couch should be withdrawn from use immediately. The couch must not be used until the fault is rectified.

A.6 Any damage threatening security of the couch that occurs between inspections, and which has already been corrected should be entered in the logbook.

A.7 Faults and damage should be reported to the manufacturer/dealer. This feedback must be entered in the logbook. Annex A

Operating Manual

3-part Treatment Couch

Annex B Daily inspection before use

Nr.	Check	Remarks
1	<ul style="list-style-type: none">All parts in place, no loose parts	
2	<ul style="list-style-type: none">No electrical defects, actuator, cables	
3	<ul style="list-style-type: none">No abnormal noise from actuator or control box	
4	<ul style="list-style-type: none">No rust or surface damage	
5	<ul style="list-style-type: none">No visual or other damage	
6	<ul style="list-style-type: none">Wheel and brake function	
7	<ul style="list-style-type: none">Check bolts and mounted parts are properly fixed on couch as well as accessories, to prevent undue slackness and spaces	

Daily cleaning

Remove hair and dust around the wheels.

Clean couch with a damp cloth.

Clarification:

The couch should be cleaned with cleaning or disinfection liquid, using a brush or sponge, and thereafter washed. Dry thoroughly after wash.

Concentrated disinfection liquid must not be used.

100% chlorine solution must not be used.

Automatic wash machines must not be used.

For cleaning of wheels, corrosion-free liquid must be used.

The mattress should be cleaned on both sides with a damp cloth and soap.



Warning!
High pressure cleaner must not be used



Warning!
Steam cleaning must not be used



Warning!
Machine wash must not be used

Operating Manual

3-part Treatment Couch

Annex C Recommended annual service inspection

Date:		Product ID/serial no.:
Carried out by:		
Service at:		

No.	Check	Remarks
	Visual check of product	
1	- wear	
2	- distortion	
3	- general damage	
4	- rust	
5	- stability no loose parts	
6	- wheels running easily	
7	- wheel lock functioning	
8	- check bed guard for wear	
9	- check mattress for holes, dirt or damage	
10	- check remote control	
	Lift motor/actuator	
11	- raise couch to maximum to ensure it stops	
12	- actuator/lift motor to be replaced after 11.000 cycles	
13	Check all functions with normal use (full load, complete cycle)	

Operating Manual

3-part Treatment Couch

	Electrical parts/connections	
14	Check all cables for wear	
15	Check all cables to ensure they will not be damaged during use	
16	Check all cables are free of damage	
17	Check all electrical parts are equipped with readable labels.	
18	Check battery and control boxes for wear and tear	
	Other	
19	Clean and lubricate as necessary	
20	Label with date of next inspection	
21		
22		

Date: _____ Initials/signature: _____

The yearly inspection can be electronically registered in the service logbook at Rehab-Care dk ApS.

Contact Rehab-Care dk ApS for further information.

Operating Manual

3-part Treatment Couch

Annex D Drawings

D1. Drawing – Couch

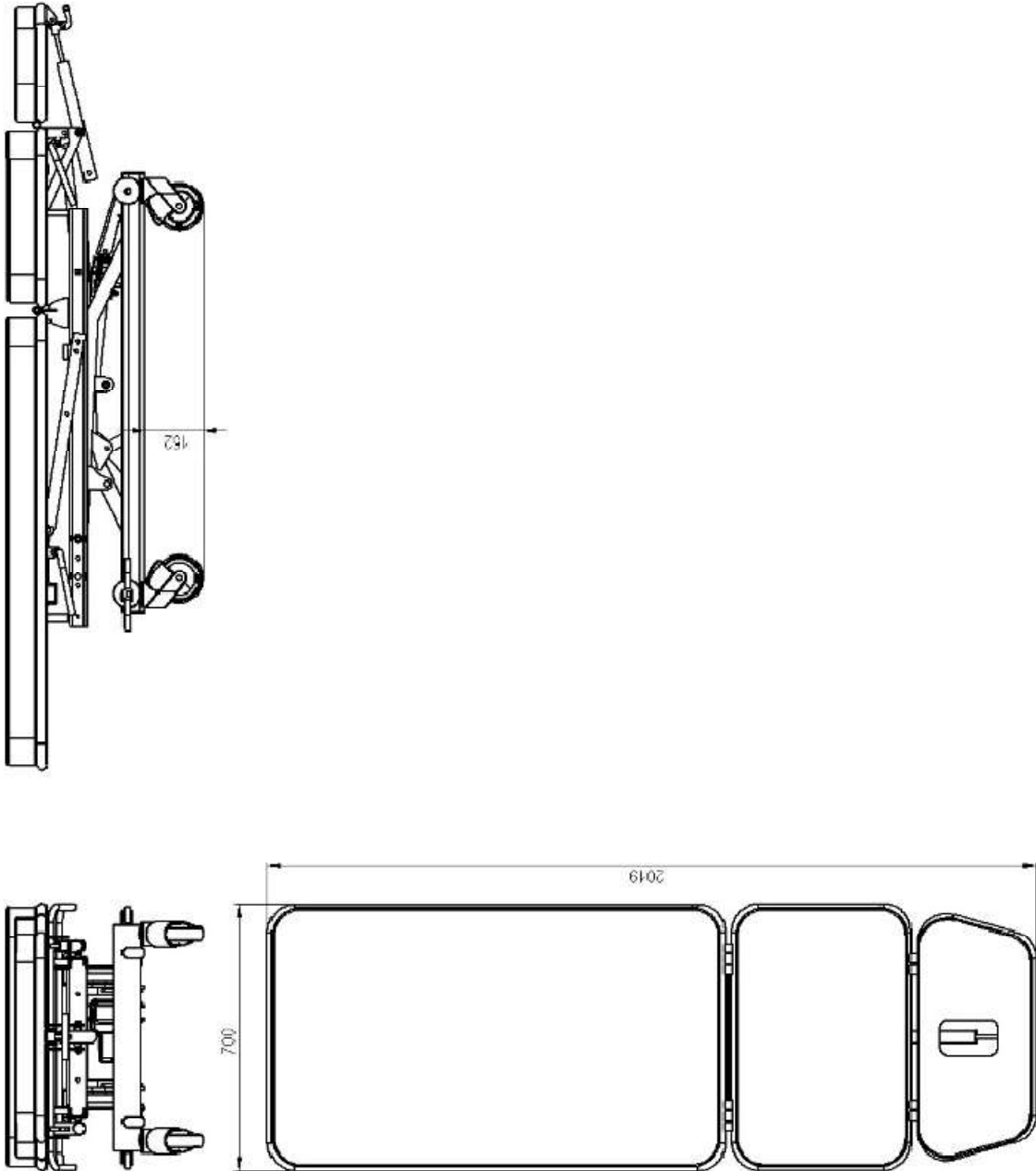

Operating Manual 3-part Treatment Couch

Annex E Spare parts list

ITEM NO.	PART NUMBER	Description	QTY.
1	L53-H	Gliedeloed	4
2	F3-motor		1
3	F2	Hoved-stykke	1
4	F*-200	Saederamme fys	1
5	F 0	Udloeserhaendtag fys	1
6	F 2	Holder til gas	1
7	GA\$-02		3
8	GA\$-17		1
9	F 1	Laesehus narke fysleje	4
10	GAS-12-500N	Gasfjeder 500N	2
11	W6--000	Topramme	1
12	L36	Forlaenger til gasfjeder	2
13	S029-2	Cphaeng til gas	1
14	S029-3	Cphaeng til gas	1
15	U8	Udloese-bojle 2 gas	2
16	ø20 stop	Plastprop	2
17	GF-500N	Blaekerebar gasfjeder 500N	1
18	GA\$-18		1
19	L40	Bøsning plas-	2
20	L 6-8	Afstandør L=12	2
21	ISO 7380 - M10 x 16 - 1.6N		2
22	0404001	Løffemotor MOT-38	1
23	M4	Saks udvendig	1
24	5444-46P1*125R36-34	Hjul ø125	4
25	L-3000	Bundramme saks	1
26	M5	Saks indv.	1
27	L45	Plast bøsning ø16-20	4
28	L6-A	øeffe laske	2
29	L 6-2	Afstandør ø16x13	4
30	L-3000-03	Forbindelsesplade saks	1
31	SKA28-1	Medaringer bremse	2
32	L-3000-22	Forbindelsesplade saks	1
33	ISO 7380 - M12 x 30 - 30N		4
34	ISO 7380 - M8 x 20 -- 20N		2
35	4032 - M8 - W - N		1
36	L-3010-01	Bremse stang	1
37	Hexagon Nut ISO - 4032 - M8 - W - N	Bremsepedal	1
38	Pedal-højle	Bremsepedal	1
39	Pedal-venstre	Bremsepedal	1
40	60X50 Flad oval	Plastprop grø 60x30 F-oval	4
41	L500	Løffetravers saks	1
42	DIN 912 M8 x 16 ---- 1.6N		2
43	DIN 912 M6 x 10 ---- 1.0N		1
44	Hexagon Nut ISO 4034 - M6 - N	Bremsestang til pedal	1
45	L42-20	Bremsestang L=560	1
46	L-3000-50	Hjul holder	4
47	PAF 20 812 P10	Krave bøsning	1

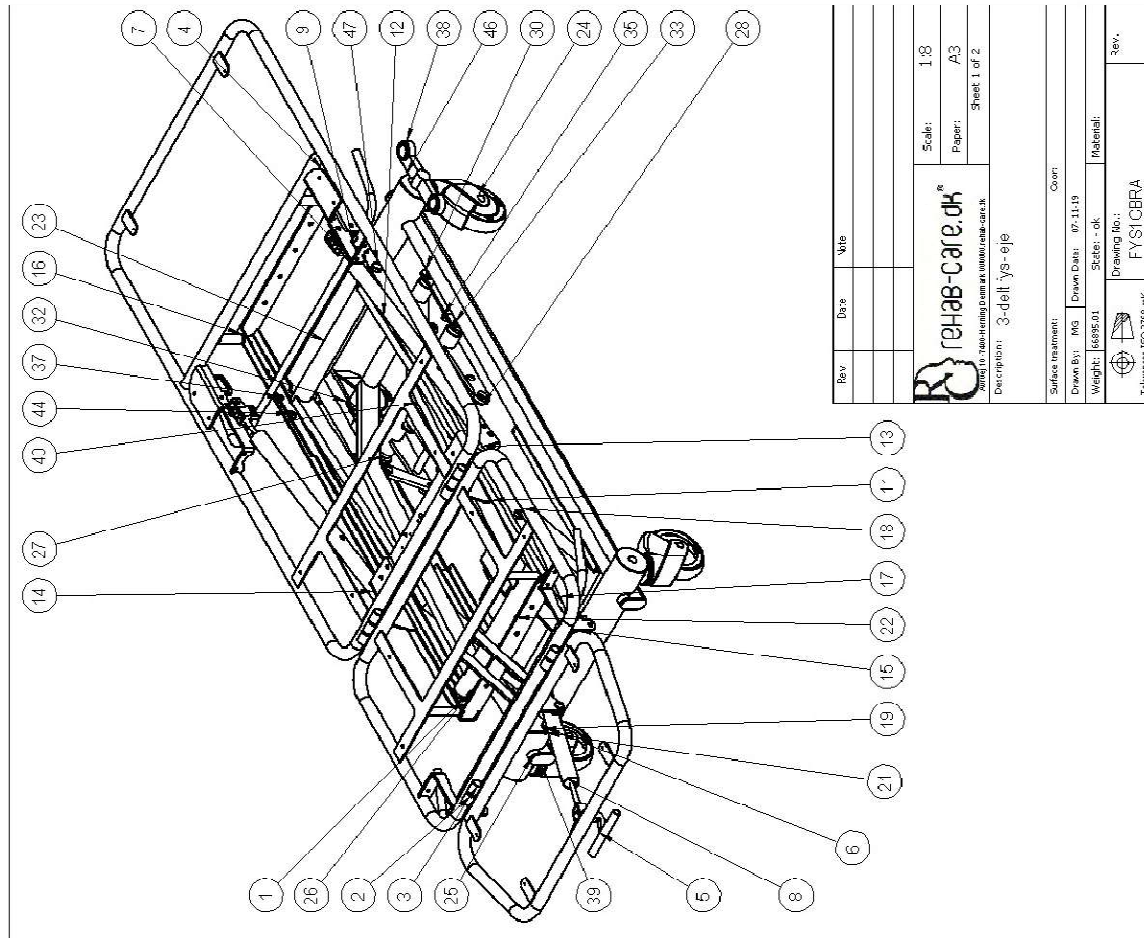

Rev	Date	Wite
rehab-care.dk		
Zang 10, Markvej 11, 4100 Slagelse, Denmark		
Description: 3-delt fys-eje		
Scale:	1:8	
Paper:	A3	Sheet 1 of 2
Surface treatment:	Covert	
Drawn By:	MG	Drawn Date:
Weight:	16895.01	Scale:
		Material:
		Drawing No.:
		Rev.:
		FYSIOBRA
		Tolerances ISO 2768-MK

Operating Manual

3-part Treatment Couch

Annex F Troubleshooting

No.	Fault	Possible cause	Solution
1	Malfunction	Is power plug on?	Switch on
2	Malfunction	Are all plugs pressed firmly in?	Press plugs in firmly
3	Malfunction	Is there visible damage to cable?	Replace cable
4	Malfunction	Battery	Replace with fully charged battery

Contact dealer if the couch is not functioning correctly.

A defect couch must not be used.

Operating Manual

3-part Treatment Couch

Appendix Battery

The couch can be equipped with different battery systems.

The following models are used: BA21 and BAT-14.

Both systems are approved in accordance with Standard 60601-1 for electrical medical equipment.

Charging

To ensure the longest possible lifetime of the battery box, charge before use.

First-time charging

before the couch is used for the first time, charge the battery for **24 hours** to ensure it is fully charged to ensure the longest possible lifetime for the battery.

Subsequent charging

Subsequently, the battery has a charge time of **4 hours**.

NOTICE:

With storage of longer than 6 months from the production date, the battery must be charged every 6 months.

NOTICE:



The battery can be damaged if it is fully discharged between charges.



Warning! Couch must not be in use during charging



Warning! Battery must not be charged in wet rooms, bathrooms or similar.

BA21	BAT-14
	
IPX6	IPX6
Color: grey	Color: White and red
Class 1 electrical safety	Class 1 electrical safety
Use 2 minutes continuously, thereafter 18 minutes disconnected	Use 2 minutes continuously, thereafter 18 minutes disconnected
Working temperature: +5 - + 40 degrees C	Working temperature: +5 - + 40 degrees C