

Operating Manual for ErGo Tilt 3000 Electrical Toilet, Bath and Hygiene Chair

05-2017



Operating Manual for ErGo Tilt 3000 Electrical Toilet, Bath and Hygiene Chair

05-2017

1. Contents

1. Contents.....	2
1. Introduction	3
2. Unpacking	3
3. General Safety Regulations	4
4. Area of Use	5
5. Use of the Chair	5
6. Expected lifespan of the product.....	6
7. Equipment and Accessories.....	6
8. Power connection.....	6
9. Charging of Batteries.....	7
10. Changing of Batteries.....	8
11. Electrical Manual Operation	8
12.Brakes	9
13. Manoeuvring instructions	9
14. Handling of Unit Parts	10
15. Cleaning.....	10
16. Maintenance.....	10
17. Service	10
18. Transport and storage	11
19. Disposal	11
20. Electromagnetic – EMC influence	11
21. Guarantee	12
22. Technical Specifications.....	13
23. Symbol Explanations.....	14
Annex A Periodic inspection.....	15
Annex B Daily inspection before use.....	16
Annex C Guidance, Yearly Inspection of chair.....	17
Annex D Drawing	19
Annex E Spare parts list.....	20
Annex F Troubleshooting	21

Operating Manual for ErGo Tilt 3000 Electrical Toilet, Bath and Hygiene Chair

05-2017

1. Introduction

RehabCare congratulates you on your new equipment.

RehabCare Toilet and Bath Chair is a modern and up-to-date product based on our long experience in the field. This Chair enables you to enhance function, quality and handling in one optimal solution.

Through continual development in all phases of our production process we endeavor to ensure conscientiousness and quality. Therefore Rehab-Care can guarantee a very reliable and functional high-quality product. Satisfied customers are the primary goal in our product development.

The Chair fulfils requirements in respect of the medical directive for class 1 products (Medical Devices Regulation (EU) 2017/745 - MDR), EN 60601-1: 2015, EN60601-1-2: 2015, ISO 17966: 2016.

Thank you for your confidence in our products and for your collaboration.

Sincerely

Rehab Care DK ApS.

Version 21-08-2024

Manufacturer:



Agent:

2. Unpacking

Carefully unpack the chair. Check that all parts and accessories are included.

Check the chair for eventual transport damage.

We recommend that the chair be cleaned before use, see cleaning instruction.

Contact the agent or manufacturer if the chair is damaged or non-functioning.

Operating Manual for ErGo Tilt 3000 Electrical Toilet, Bath and Hygiene Chair

05-2017

3. General Safety Regulations



Warning!
Do not use a high-pressure cleaner on the product.



Warning!
Do not use chemicals, and carry out a yearly service inspection for damage



Warning!
Only use the remote control delivered with the product.



Warning!
Dirt in the wheels can damage/destroy the chair's wheels.



Warning!
Do not use wheels other than those recommended by the manufacturer.



Warning!
Children must not use the chair without supervision. It is not a toy!



Warning!
The chair must not lift more than 200 kg

Warning!
Use only the recommended seat and other parts of the chair.



Warning!
Before and during a lift, ensure there is no danger of crushing for user or helper.



Warning!
The chair must not be used if a malfunction is suspected.



Warning!
Do not lift the user higher than necessary, and do not tilt the chair more than necessary.



Warning!
The chair can overturn if used incorrectly. Personal injury can occur if warnings and instructions are disregarded. Read instructions carefully before using the chair.

Attention! Before use:

To avoid injury during handling and use of the chair, the instructions for safety and use should be read and understood.

Before use, follow the checklist at the end of the Instructions for Use.

Operating Manual for ErGo Tilt 3000 Electrical Toilet, Bath and Hygiene Chair

05-2017

4. Area of Use

The Chair is for use in a private home, care homes and hospitals

In toilet-, bath- and sanitary areas.
In the care of wounds, skin and feet.
Washing of hair.
Dressing and undressing.
As transport to toilet/bathroom, etc.

The chair is intended for indoor use.

The chairs Safe Working Load (SWL) is made up as follows: Equipment: 25 kg. – User: 175 kg.
SWL: 200 kg.



Warning!
The chair must not lift more than **200 kg**.

5. Use of the Chair

- The chair is for use for general toilet- and bath situations, transport to and from the toilet, transport between bed and wheelchair, dressing and undressing.
- The helper should be aware of all necessary general and safety instructions before the user is lifted with the chair.
- The chair must only be used in accordance with Instructions for Use and by personnel instructed in its correct use.
- The helper should try the chair together with a colleague before lifting the user.
- The user must be instructed in the use of the chair by the helper before using it for the first time.
- Persons with physical or psychological limitations must not use the product without supervision, or unless they have first been instructed in the proper use of the chair and its equipment.
- Children must be under supervision to ensure that they do not play with the product.
- The helper is responsible for ensuring the chair is not defective; therefore a visual control of the chair should be made before a lift. The Agent should be contacted immediately in case of defects.
- Ensure all wheels are unlocked before moving the chair.

Operating Manual for ErGo Tilt 3000 Electrical Toilet, Bath and Hygiene Chair

05-2017

6. Expected lifespan of the product

The product has an expected lifespan of 15 years.

Lifespan is based on the correct use, cleaning, service and maintenance.

If the chair is to be used longer than the above mentioned expected lifespan, it should be assessed by qualified service personnel before future use.

It is the helpers' responsibility to assess whether the product can be used over the expected lifespan.

Electrical parts must only be serviced by a qualified technician.

7. Equipment and Accessories

The chair comprises:

- Frame with 4 wheels
- Electrical adjustment via hand control
- Electrical adjustment of the seat angle,
- Battery function
- Removable battery

Optional accessories:

- Footrest with adjustable plate
- Seat cushion with diverse openings
- Legstrap in artificial leather
- Back support in artificial leather
- Extra battery
- Leg rest
- Body/side support
- Safety guard
- Hemi-armrest
-
- And more. Please see RehabCare's complete accessory list.

8. Power connection

The chair connects to AC power 230V via net-plug to the lift.

The chair should not be connected to AC power during use, the lift is equipped with a battery. N.B. the chair cannot be used when charging the battery.

When the net-plug is not in use, hang the cable with plug on the block on the back of the chair.



Before using, check the cable for breaks or splits.

Operating Manual for ErGo Tilt 3000 Electrical Toilet, Bath and Hygiene Chair

05-2017

9. Charging of Batteries

The battery should be charged before use to ensure the longest possible lifespan. Charging time depends on the condition of the battery.

Before the chair is used for the first time, charge the battery for 24 hours to ensure that it is fully charged.

Batteries should be regularly charged, it is recommended that they be charged after a day's use.

The lifespan of the batteries can be strongly reduced if they are allowed to become completely flat between charging.

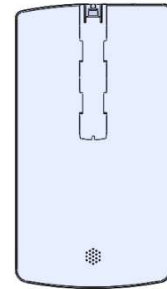

Green battery

In comparison with a lead battery, a Lithium-Ion battery is an environmentally friendly product:

- less CO2 emission and reduced environment footprint
- longer lifespan, therefore less transport of batteries (fewer batteries)
- longer lifespan, therefore less waste (fewer batteries)
- 50% weight reduction in comparison with lead batteries, therefore less weight to transport

LED functionality, indication of status:

- | | |
|--------------------|-----------------------|
| - Yellow: | Charging |
| - No light showing | fully charged |
| - Flashing yellow | Error during charging |

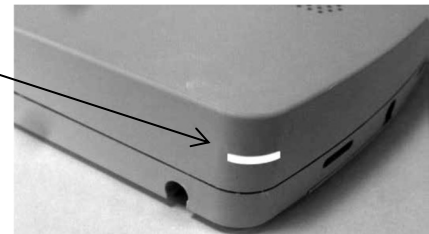

Charging via Net stick

Motor function cannot be used during charging.

Buzzer function.

A warning buzzer will sound when the battery capacity is low and a button is pushed on the remote control.

Technical info.:

Approved: IEC60601-1:2005 3rd edition.

Capacity: 2.25 Ah/58.28 Wh.

IP class: IPX6 Washable.

Weight: 0,7kg.

Built-in charger in battery

Operating Manual for ErGo Tilt 3000 Electrical Toilet, Bath and Hygiene Chair

05-2017

10. Changing of Batteries





Changing of batteries must only be undertaken by qualified personnel.
Use only original spare parts.

11. Electrical Manual Operation

1 Seat angle.

-5 to 30 degree adjustment for chair's seat, up/down



-  Before and during a lift, ensure that no injury can be incurred by helper or user
-  When lifting, ensure that SWL is not exceeded
-  The chair should tilt smoothly and without difficulty
-  Do not tilt the chair more than necessary

Operating Manual for ErGo Tilt 3000 Electrical Toilet, Bath and Hygiene Chair

05-2017

12.Brakes

Brakes		All 4 wheels have a brake function Press brake pedal down to activate the brake Always activate the brake when parking the chair
--------	---	--

13. Manoeuvring instructions

1. The chair should be set to the lowest possible position when moving a user, according to the needs of the user.
2. By using the remote control, the helper can be close to the user and create a feeling of security
3. The chair should be pulled during a move, this gives a smoother ride for the user, and at the same time puts less strain on the helper
4. The helper should stand at the side of the chair when turning. The chair should be turned on its own axis; the helper pulling with one hand on the chair's back-/maneuvering guard. When using the chair, it is recommended that the helper uses the whole body and not twists torso and shoulders.
5. The helper must always check on the chair's stability and that there is no risk of overturning. Check for obstacles in the chair's path.
6. Be prepared for the task: move a wheelchair to the chair, or the chair to a bed.
7. Push or pull the chair smoothly; hasty movements are uncomfortable for the user and an abrupt stop can be a safety danger.
8. Pull the chair if it must go over a doorstep or other obstacle, this makes the movement smoother and safer.
9. Do not lift the chair, this is dangerous for both helper and user.
10. Always use the wheel brakes when the user is in the chair.
11. Do not raise/tilt the user more than necessary.
12. Never stand on the footrests; this could injure the user and/or helper and damage the product.

Operating Manual for ErGo Tilt 3000 Electrical Toilet, Bath and Hygiene Chair

05-2017

14. Handling of Unit Parts

Footrests and leg supports. None of the accessories weighs more than 11 kg.

15. Cleaning

Metal parts of the chair can be cleaned with cleaning or disinfectant fluid.

The chair can be cleaned in accordance to SSI and MRSA. Also with ethanol 70-85%, chlorine 1000-1200 ppm and chlorine cloths (wet serviettes).

The wheels must only be cleaned with products not containing corrosive or damaging materials. The chair is made to be washed in a wash-machine/tunnel.

16. Maintenance

- Wheels must be free of hair, soap, and dirt.
- Yearly service is recommended.
- Moving parts should be checked, tightened and greased.
- Worn chairs should be replaced.
- Battery should be replaced as necessary.

17. Service

The chair should undergo a yearly service, carried out by qualified personnel. The yearly service is compulsory according to standard EN ISO 17966. It is the owner's responsibility to ensure the yearly service is undertaken. A service protocol should be established for the serviced chair, and be signed by the customer after every service.

If the service technician discovers a serious fault during service, it is the technician's duty to remove the chair if the fault constitutes a safety risk.

Service, repairs and other additional work on the chair between services should be noted in the service protocol.

17.1 Service – ACTUATORERS

The actuator is kept clean and lubricated on the piston rod during annual servicing.

The actuator/lift motor should be replaced after 11.000 cycles.

Replacement of the actuator must only be carried out by authorized service personnel.

17.2 Service - WHEELS

Wheels should be regularly serviced as necessary, usually tightening.

The wheels have closed bearings; therefore greasing is not necessary.

Cleaning fluids containing corrosive or damaging materials must not be used

Wheels and parts should be replaced as soon as they no longer run smoothly.

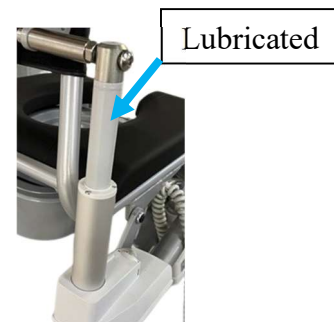

Operating Manual for ErGo Tilt 3000 Electrical Toilet, Bath and Hygiene Chair

05-2017

18. Transport and storage

If the chair is not to be used for a long time, it is recommended that it be covered to protect it from dust and dirt. It is also recommended that the battery be removed as its lifespan is severely reduced if allowed to become completely discharged.

The chair should be stored in a frost-free environment with normal air humidity (80%).

Requirements for storage and transport:

- Air humidity between 10 and 80%
- Temperature between -30 and 40 degrees C
- Pressure between 700-1100 hPa

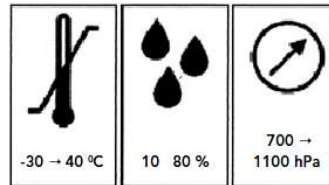

19. Disposal

For disposal, separate the chair into electronic and metal waste.

Electronic waste should be disposed of according to regulations in force, and must not be disposed of with general waste.

20. Electromagnetic – EMC influence

- Portable and mobile RF communication equipment (for example cell phones) can influence electronic medical equipment, and should be kept at a distance of at least **35cm.** from the medical equipment.
- Use of other than the specified accessories and cables can result in higher emissions or reduce the unit's immunity. Use of unauthorized cable and accessories can negatively influence EMC efficiency.
- Electrical parts: Steering, motor and cable details can be found in the spare-parts list belonging to the product.
- Mains-supply electricity should be of the normal quality found in industrial and hospital environments.
- Correct maintenance is important to uphold EMC requirements.
- In the event of EMC noise from the product, contact the manufacturer.
- Other conditions concerning EMC: None.

Operating Manual for ErGo Tilt 3000 Electrical Toilet, Bath and Hygiene Chair

05-2017

21. Guarantee

There is a 2-year guarantee on the chair.

The guarantee becomes invalid in the following cases:

1. Overloading the chair.
2. Violent use of the chair.
3. Handling fault, wrong use of the chair
4. Absence of, or wrong maintenance.
5. If the electrical LINAK parts have been opened or used wrongly.
6. Damage to the surface, scratches and mechanical interference.

At RehabCare we are continuously endeavoring to improve our products.

We therefore reserve the right to change our products without prior notification.

All measurements given in the drawings or other material are only guidelines, and subject to errors.

Operating Manual for ErGo Tilt 3000 Electrical Toilet, Bath and Hygiene Chair

05-2017

22. Technical Specifications

22.1 Measurements and Weight

Max. load	200 kg
Lift space, measured from seat	43,2 – 55,7 cm.
Tilt angle	-5 to+30 degree
Number of tilts with 100 kg.	60 tilts
Chair – outside width	59 cm.
Free height under seat in chair's lowest position	42 cm.
Free height of frame	7 cm.
Length of frame	67 cm.
Wheel diameter	Ø125 mm
Turning radius	Approx..43 cm.
Total weight	15 kg
Noise level	Under 50 dB
Surface	E-Coating and powder coating
RAL color standard	RAL9006.
Power force for activation of remote control	Under 5N

22.2 Electrical data

Power supply	24V DC
Current	10 A
Protection class for electrical components	IPx6 W

Operating Manual for ErGo Tilt 3000 Electrical Toilet, Bath and Hygiene Chair

05-2017

23. Symbol Explanations

The following symbols are used on labels or in this Manual:



Warning, see attached document.



User information



Class 2 equipment



Type B equipment (EN 60601-1)



For indoor use



Medical Equipment.



CE approval MDR (Medical Device Regulation) 2017/745

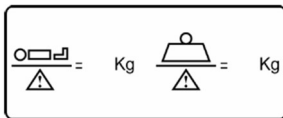

Safe Working Load (SWL) = Patient Max. Weight. + equipment



production address.



Production date.



Product item no.



Product serial no.



unique equipment identifier.

Product label. (example).

Rehab Care
 Avnvej 10
 7400 Herning
 Danmark
 29-07-2024
 REF AKUT-14000

MAX LOAD:
 250 kg

POWER:
 230V/24V5Amp

DUTY CYCLE:
 10 %

UDI 10013
 SN 10013

MANUAL

(01)05745000344130(11)240729(10)1005(21)10013

Annex A Periodic inspection

A.1 Periodic inspection of the chair should be undertaken as recommended by the manufacturer, at least once a year. Periodic inspection includes visual inspection, especially of the chair's support structure, hoist, brakes, steering, safety and personal aids, as well as a functionality test and any necessary maintenance, e.g. brake adjustment, tightening of screws, etc.

Every inspection must include a test of one (1) lift cycle with the maximum load.

A.2 Periodic inspection must be undertaken by a suitably qualified person with knowledge of both the construction, use and maintenance of the chair.

A.3 All observations and remarks should be noted in a logbook held by the person(s) responsible for servicing/maintenance of the chair.

The date when the chair is repaired according to any observations made under the inspection, should also be noted in the logbook.

A.4 The date when the inspection of the chair is undertaken, and the result of the inspection should be noted in the logbook together with the signature of the inspector.

A.5 If the periodic inspection reveals faults, wear or other damage which constitutes a safety risk, the owner should be informed immediately. In the case of a direct safety risk the chair must be taken out of service immediately. The chair must not be used before it is repaired.

A.6 Faults and serious damage which could constitute a safety risk, and which occur between inspections, but which have been corrected and repaired should also be noted in the logbook.

A.7 Faults and damage should be reported to the manufacturer/dealer. This feedback should be noted in the logbook.

Operating Manual for ErGo Tilt 3000 Electrical Toilet, Bath and Hygiene Chair

05-2017

Annex B Daily inspection before use

Nr.	Check	Remarks
1	<ul style="list-style-type: none">All parts in place, no loose parts	
2	<ul style="list-style-type: none">There are no defects in el-parts, actuator, cables	
3	<ul style="list-style-type: none">There are no abnormal sounds from the actuator or steering box	
4	<ul style="list-style-type: none">The chair has no rust or surface damage.	
5	<ul style="list-style-type: none">The chair shows no sign of other damage.	
6	<ul style="list-style-type: none">Wheels and wheel brake function	
7	<ul style="list-style-type: none">Quick guide can be found on the chair	
8	<ul style="list-style-type: none">Check battery charging indicator	

Daily cleaning

Remove hair, soap and dirt around the wheels

Clean the chair with a damp cloth

The chair should be cleaned with cleaning or disinfectant fluid with a brush or sponge. Rinse, then dry thoroughly.

Harsh dissolvent must not be used.

100% chlorine solution must not be used.

When cleaning the wheels, cleaning fluids must not contain corrosive or damaging material



Warning!!

Never use a high pressure hose on the product.

Operating Manual for ErGo Tilt 3000 Electrical Toilet, Bath and Hygiene Chair

05-2017

Annex C Guidance, Yearly Inspection of chair

(To be completed by the person responsible, with further control as deemed necessary)

Date:		Product ID / serial nr.:
Carried out by::		
Inspection carried out at:		

Nr.	Check	Bemærkning
	Visuel kontrol af produkt	
1	- Damage	
2	- Distortion	
3	- general damage	
4	- rust	
5	- stability – no loose parts	
6	- wheels run smoothly	
7	- loose wheels	
8	- check lift motor for wear	
Nr.	Check	Remarks
	Lift motor/actuator/control box	
9	- Tilt seat to maximum and ensure it stops	
10	- actuator/lift motor must be replaced after 11.000. - Piston rod on actuators must be lubricated	
11	Control of all functions for normal use: (tested with maximum load, a complete cycle. Should run smoothly and without noise)	
12	- check battery/charging indicator	
Nr.	Check	Remarks
	Electrical parts/connections:	
13	Check all cables are undamaged	

Operating Manual for ErGo Tilt 3000 Electrical Toilet, Bath and Hygiene Chair

05-2017

14	Check all cables are in place and cannot be trapped during use	
15	Check the cables and insulation for splits,	
16	Check all electrical parts have legible labels	
Nr.	Check	Remarks
	Additional:	
17	Clean and grease as necessary	
18	Attach label with the date of the next inspection	

Date: _____ Initials/Signature _____

**The yearly inspection can be registered electronically in the product's service log, by RehabCare.
Contact RehabCare for further information.**

Operating Manual for ErGo Tilt 3000 Electrical Toilet, Bath and Hygiene Chair

05-2017

Annex D Drawing

D1. Drawing - ErGo Tilt 3000

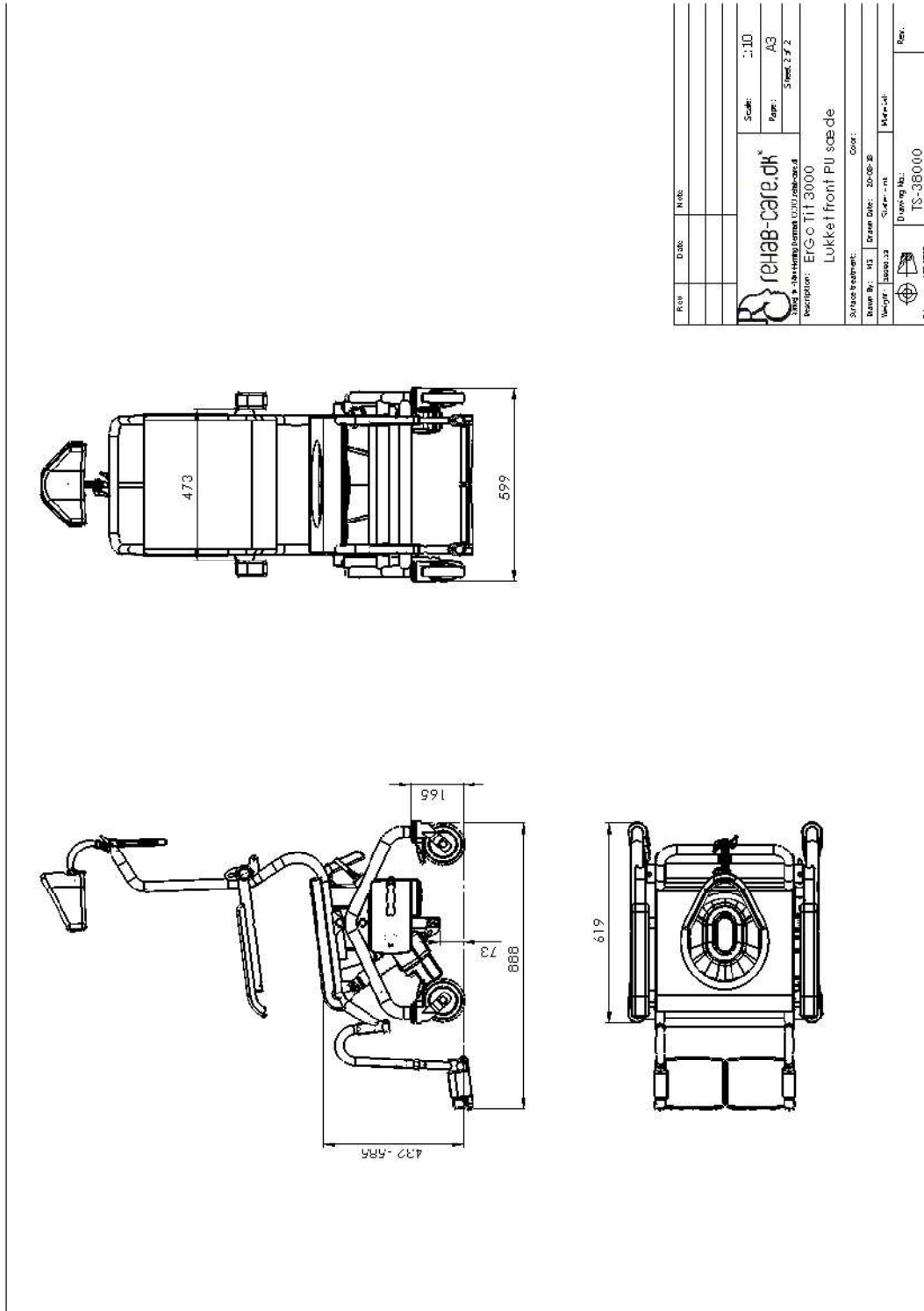

Operating Manual for ErGo Tilt 3000 Electrical Toilet, Bath and Hygiene Chair

05-2017

Annex F Troubleshooting

Nr.	Fault	Possible cause	Solution
1	Function failure	Is the power switched on?	Switch on
2	Function failure	Is the battery fully charged?	If no – charge battery If yes – check all connections
3	Function failure	Are all plugs correctly connected?	Press plug firmly
4	Function failure	Are there visible splits/damage to the cable?	Replace cable
5	Function failure	Battery cannot be charged	Battery can be defective – contact dealer

Contact the dealer if the chair does not function correctly.