

# Operating Manual for ErGo OpTi Electrical Toilet, Bath and Hygiene Chair



## Multifunction Chair



# Operating Manual for ErGo OpTi Electrical Toilet, Bath and Hygiene Chair

---

## 1. Contents

1. Contents.....	2
1. Introduction .....	3
2. Unpacking .....	3
3. General Safety Regulations .....	4
4. Area of Use .....	5
5. Use of the Chair .....	5
6. Expected lifespan of the product.....	5
7. Equipment and Accessories.....	6
8. Power connection.....	6
9. Charging of Batteries.....	7
10. Changing of Batteries.....	8
11. Electrical Manual Operation .....	8
12.Brakes .....	9
13. Emergency stop / Lowering.....	9
14. Manoeuvring instructions .....	10
15. Handling of Unit Parts .....	10
16. Cleaning.....	11
17. Maintenance.....	11
18. Service .....	11
19. Transport and storage .....	12
20. Disposal .....	12
21. Electromagnetic – EMC influence .....	12
22. Guarantee .....	12
23. Technical Specifications.....	13
24. Symbol Explanations.....	14
Annex A Periodic inspection.....	15
Annex B Daily inspection before use.....	16
Annex C Guidance, Yearly Inspection of chair .....	17
Annex D Drawing .....	19
Annex E Spare parts list.....	20
Annex F Troubleshooting .....	21
Annex G EMC Form.....	21

# Operating Manual for ErGo OpTi Electrical Toilet, Bath and Hygiene Chair

---

## 1. Introduction

Rehab Care congratulates you on your new equipment.

Rehab Care Toilet and Bath Chair is a modern and up-to-date product based on our long experience in the field. This Chair enables you to enhance function, quality and handling in one optimal solution. Through continual development in all phases of our production process we endeavor to ensure conscientiousness and quality. Therefore, Rehab Care can guarantee a very reliable and functional high-quality product. Satisfied customers are the primary goal in our product development.

The Chair fulfils requirements in respect of the medical directive for class 1 products (Medical Devices Regulation (EU) 2017/745 - MDR), EN 60601-1: 2015, EN60601-1-2: 2015, ISO 17966: 2016. Thank you for your confidence in our products and for your collaboration.

**Sincerely**

**Rehab Care DK ApS.**

Version 29-10-2024

Manufacturer:



Agent:

## 2. Unpacking

Carefully unpack the chair. Check that all parts and accessories are included.  
Check the chair for eventual transport damage.

We recommend that the chair be cleaned before use, see cleaning instructions.

Contact the agent or manufacturer if the chair is damaged or non-functioning.

# Operating Manual for ErGo OpTi Electrical Toilet, Bath and Hygiene Chair

---

## 3. General Safety Regulations



Warning!  
Do not use a high-pressure cleaner on the product.



Warning!  
Do not use chemicals, and carry out a yearly service inspection for damage



Warning!  
Only use the remote control delivered with the product.



Warning!  
Foreign bodies in the wheels can damage/destroy the chair's wheels.



Warning!  
Do not use wheels other than those recommended by the manufacturer.



Warning!  
Children must not use the chair without supervision. It is not a toy!



Warning!  
The chair must not lift more than 200 kg

Warning!  
Use only the recommended seat and other parts of the chair.



Warning!  
Before and during a lift, ensure there is no danger of crushing for user or helper.



Warning!  
The chair must not be used if a malfunction is suspected.



Warning!  
Do not lift the user higher than necessary, and do not tilt the chair more than necessary.



Warning!  
The chair can overturn if used incorrectly. Personal injury can occur if warnings and instructions are disregarded. Read instructions carefully before using the chair.

### **Attention! Before use:**

To avoid injury during handling and use of the chair, the instructions for safety and use should be read and understood.

# Operating Manual for ErGo OpTi Electrical Toilet, Bath and Hygiene Chair

---

## 4. Area of Use

The Chair is for use in a private home, care homes and hospitals

In toilet-, bath- and sanitary areas.  
In the care of wounds, skin and feet.  
Washing hair.  
Dressing and undressing.  
As transport to toilet/bathroom, etc.

The chair is intended for indoor use.

The chairs Safe Working Load (SWL) are made up as follows: Equipment: 25 kg. – User: 175 kg.  
SWL: 200 kg.



Warning!  
The chair must not lift more than **200 kg**.

## 5. Use of the Chair

- The chair is for use for general toilet- and bath situations, transport to and from the toilet, transport between bed and wheelchair, dressing and undressing.
- The helper should be aware of all necessary general and safety instructions before the user is lifted with the chair.
- The chair must only be used in accordance with Instructions for Use and by personnel instructed in its correct use.
- The helper should try the chair together with a colleague before lifting the user.
- The user must be instructed in the use of the chair by the helper before using it for the first time.
- People with physical or psychological limitations must not use the product without supervision, or unless they have first been instructed in the proper use of the chair and its equipment.
- Children must be under supervision to ensure that they do not play with the product.
- The helper is responsible for ensuring the chair is not defective; therefore, visual control of the chair should be made before a lift. The Agent should be contacted immediately in case of defects.
- Ensure all wheels are unlocked before moving the chair.

## 6. Expected lifespan of the product

# Operating Manual for ErGo OpTi Electrical Toilet, Bath and Hygiene Chair

---

The product has an expected lifespan of 15 years.

Lifespan is based on the correct use, cleaning, service and maintenance.

If the chair is to be used longer than the above-mentioned expected lifespan, it should be assessed by qualified service personnel before future use.

It is the helpers' responsibility to assess whether the product can be used over the expected lifespan.

Electrical parts must only be serviced by a qualified technician.

## 7. Equipment and Accessories

### **The chair comprises:**

- Frame with 4 wheels
- Electrical adjustment via hand control
- Electrical adjustment of the seat angle,
- Emergency lowering
- Emergency stop
- Battery function
- Removable battery

### **Optional accessories:**

- Footrest with adjustable plate
- Seat cushion with diverse openings
- Leg strap in artificial leather
- Back support in artificial leather
- Extra battery
- Battery charger
- Leg rest
- Body/side support
- Safety guard
- Hemi-arm rest
- 
- And more. Please see Rehab Care's complete accessory list.
- 

## 8. Power connection

The chair connects to AC power 230V via net-plug to the lift.

# Operating Manual for ErGo OpTi Electrical Toilet, Bath and Hygiene Chair

The chair should not be connected to AC power during use, the lift is equipped with a battery. N.B. the chair cannot be used when charging the battery.

When the net-plug is not in use, hang the cable with plug on the holder on the headrest.

 Before using, check the cable for breaks or splits.

## 9. Charging of Batteries

The battery should be charged before use to ensure the longest possible lifespan. Charging time depends on the condition of the battery.



Before the chair is used for the first time, charge the battery for 24 hours to ensure that it is fully charged.

Batteries should be regularly charged; it is recommended that they be charged after a day's use.

The lifespan of the batteries can be strongly reduced if they are allowed to become completely flat between charging.

When the last indicator light on the remote control is on, the battery **MUST** be charged.

The battery can be charged in two ways:

- Connect net cable direct to net-plug
- Remove battery and place in charger (extra accessory).



### Green battery

In comparison with a lead battery, a Lithium-Ion battery is an environmentally friendly product:

- less CO2 emissions and reduced environmental footprint
- longer lifespan, therefore less transport of batteries (fewer batteries)
- longer lifespan, therefore less waste (fewer batteries)
- 50% weight reduction in comparison with lead batteries, therefore less weight to transport

LED functionality, indication of status:

**(also shown under Remote Control)**

- |                    |                       |
|--------------------|-----------------------|
| - Yellow:          | Charging              |
| - No light showing | Fully charged         |
| - Flashing yellow  | Error during charging |

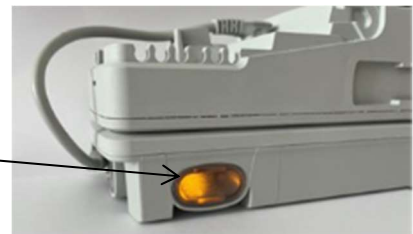

### Charging via Net stick

Motor function cannot be used during charging.

Buzzer function.

A warning buzzer will sound when the battery capacity is low, and a button is pushed on the remote control.

# Operating Manual for ErGo OpTi Electrical Toilet, Bath and Hygiene Chair

## Technical info.:

Approved: IEC60601-1:2005 3rd edition.

Capacity: 2.9 Ah/73.25 Wh

IP class: IPX6 Washable.

Weight: 1kg.

**Built-in charger in battery**

## 10. Changing of Batteries

Changing of batteries must only be undertaken by qualified personnel.  
Use only original spare parts.

## 11. Electrical Manual Operation

### 1 Raise and lower chair

Height adjustment for chair seat, up/down

### 2 Seat angle up/down

Adjustment of the seat angle.

2a for emergency lowering, press both buttons

1) chair down, 2) seat angle horizontal

**N.B: Use only in case of button failure**

### 3 Emergency stop.

Stops all functions; when activated, diodes will flash.

**N.B: Reset by holding the button down for 3 secs.**

### 4 Battery indicators

Shows how much power is left.

3 diodes = fully charged

Incorporates light and sound signals.

**N.B: When the battery is at its lowest, the chair can only be lowered**

### 5 Charging light.

Checks the battery, shows when charging is necessary

**N.B: The chair cannot be used during charging.**

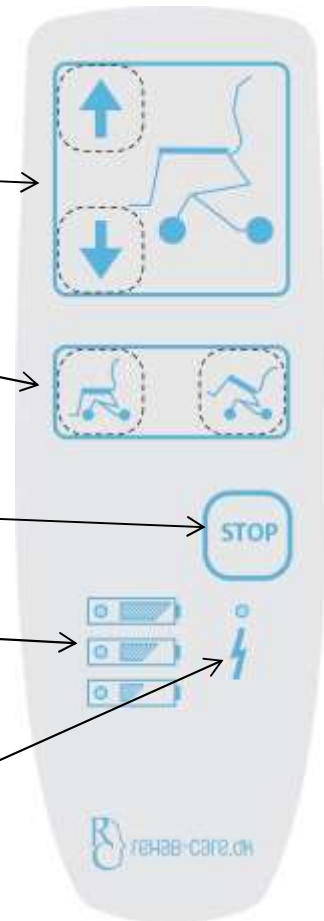

Before and during a lift, ensure that no injury can be incurred by helper or user



When lifting, ensure that SWL is not exceeded



The Multifunction chair should elevate and lower smoothly and without difficulty



Do not lift the patient higher than necessary – and do not tilt the chair more than necessary



# Operating Manual for ErGo OpTi Electrical Toilet, Bath and Hygiene Chair

## 12.Brakes

<p>Brakes</p> 	<p>All 4 wheels have a brake function Press brake pedal down to activate the brake Always activate the brake when parking the Multifunction chair</p>
---	---

## 13. Emergency stop / Lowering

### Lowering.

Lower by holding both buttons down  
1) chair down 2) seat angle horizontal.

**N.B: Use only in case of button failure**

### Emergency Stop

Stops all functions, when activated diodes flash

**N.B: Reset by holding button down for 5 secs.**

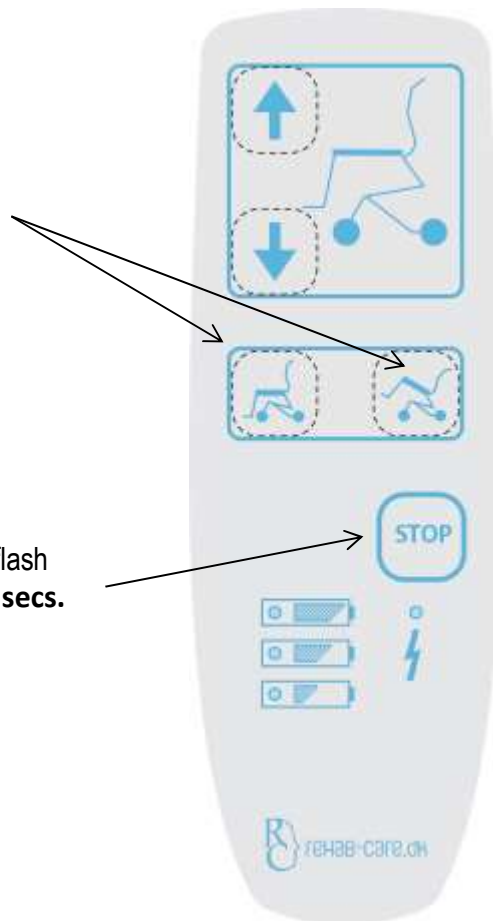

# Operating Manual for ErGo OpTi Electrical Toilet, Bath and Hygiene Chair

---

## 14. Maneuverings instructions

1. The chair should be set to the lowest possible position when moving a user, according to the needs of the user.
2. By using the remote control, the helper can be close to the user and create a feeling of security
3. The chair should be pulled during a move, this gives a smoother ride for the user, and at the same time puts less strain on the helper
4. The helper should stand at the side of the chair when turning. The chair should be turned on its own axis; the helper pulling with one hand on the chair's back-/maneuvering guard. When using the chair, it is recommended that the helper uses the whole body and not twists torso and shoulders.
5. The helper must always check on the chair's stability and that there is no risk of overturning. Check for obstacles in the chair's path.
6. Be prepared for the task: move a wheelchair to the chair, or the chair to a bed.
7. Push or pull the chair smoothly; hasty movements are uncomfortable for the user and an abrupt stop can be a safety danger.
8. Pull the chair if it must go over a doorstep or other obstacle, this makes the movement smoother and safer.
9. Do not lift the chair, this is dangerous for both helper and user.
10. Always use the wheel brakes when the user is in the chair.
11. Do not raise/tilt the user more than necessary.
12. Never stand on the footrests; this could injure the user and/or helper and damage the product.

## 15. Handling of Unit Parts

Footrests and leg support. None of the accessory's weighs more than 11 kg.

# Operating Manual for ErGo OpTi Electrical Toilet, Bath and Hygiene Chair

## 16. Cleaning

Metal parts of the chair can be cleaned with cleaning or disinfectant fluid.

The chair can be cleaned in accordance to SSI and MRSA. Also, with ethanol 70-85%, chlorine 1000-1200 ppm and chlorine cloths (wet serviettes).

The wheels must only be cleaned with products not containing corrosive or damaging materials. The chair is made to be washed in a washing machine/tunnel.

## 17. Maintenance

- Wheels must be free of hair, soap, and dirt.
- Yearly service is recommended.
- Moving parts should be checked, tightened and greased.
- Worn chairs should be replaced.
- Battery should be replaced as necessary.

## 18. Service

The chair should undergo a yearly service, carried out by qualified personnel. The yearly service is compulsory according to standard EN ISO 10535. It is the owner's responsibility to ensure the yearly service is undertaken. A service protocol should be established for the serviced chair, and be signed by the customer after every service.

If the service technician discovers a serious fault during service, it is the technician's duty to remove the chair if the fault constitutes a safety risk.

Service, repairs and other additional work on the chair between services should be noted in the service protocol.

### 18.1 Service – ACTUATORERS

The actuator/lift motor should be replaced after 11.000 cycles. The actuator is kept clean and lubricated on the piston rod during annual servicing.

Replacement of the actuator must only be carried out by authorized service personnel.

### 18.2 Service - WHEELS

Wheels should be regularly serviced as necessary, usually tightening.

The wheels have closed bearings; therefore, greasing is not necessary.

Cleaning fluids containing corrosive or damaging materials must not be used

Wheels and parts should be replaced as soon as they no longer run smoothly.

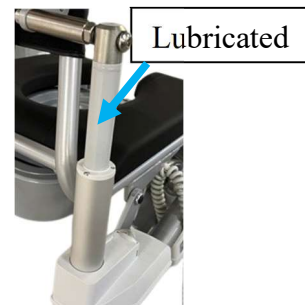

# Operating Manual for ErGo OpTi Electrical Toilet, Bath and Hygiene Chair

## 19. Transport and storage

If the chair is not to be used for a long time, it is recommended that it be covered to protect it from dust and dirt. It is also recommended that the battery be removed as its lifespan is severely reduced if allowed to become completely discharged.

The chair should be stored in a frost-free environment with normal air humidity (80%).

Requirements for storage and transport:

- Air humidity between 10 and 80%
- Temperatures are between -30 and 40 degrees C
- Pressure between 700-1100 hPa

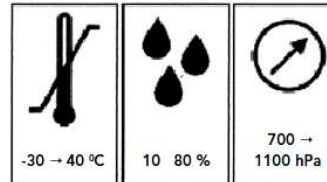

## 20. Disposal

For disposal, separate the chair into electronic and metal waste.

Electronic waste should be disposed of according to regulations in force and must not be disposed of with general waste.

## 21. Electromagnetic – EMC influence

- Portable and mobile RF communication equipment (for example cell phones) can influence electronic medical equipment and should be kept at a distance of at least **35cm.** from the medical equipment.
- Use of anything other than the specified accessories and cables can result in higher emissions or reduce the unit's immunity. Use of unauthorized cable and accessories can negatively influence EMC efficiency.
- Electrical parts: Steering, motor and cable details can be found in the spare parts list belonging to the product.
- The main supply of electricity should be of normal quality found in industrial and hospital environments.
- Correct maintenance is important to uphold EMC requirements.
- In the event of EMC noise from the product, contact the manufacturer.
- Other conditions concerning EMC: See **annex G**

## 22. Guarantee

There is a 2-year guarantee on the chair.

The guarantee becomes invalid in the following cases:

1. Overloading the chair.
2. Violent use of the chair.
3. Handling fault, wrong use of the chair
4. Absence of, or wrong maintenance.
5. If the electrical LINAK parts have been opened or used wrongly.
6. Damage to the surface, scratches and mechanical interference.

# Operating Manual for ErGo OpTi Electrical Toilet, Bath and Hygiene Chair

---

At Rehab Care we are continuously endeavoring to improve our products.  
We therefore reserve the right to change our products without prior notification.  
All measurements given in the drawings or other material are only guidelines, and subject to errors.

## 23. Technical Specifications

### 23.1 Measurements and Weight

Max. load	200 kg
Lift space, measured from seat or Tilt angle	52 – 90 cm. -5 to+90 degrees
Number of lifts with 100 kg.	60 lifts
Chair – outside width	59 cm.
Free height under seat in chair's lowest position	42 cm.
Free height of frame	11 cm.
Length of frame	67 cm.
Wheel diameter	Ø125 mm
Turning radius	Approx.43 cm.
Total weight	35 kg
Noise level	Under 50 dB
Surface	E-coating and powder coating
RAL color standard	RAL9006.
Power force for activation of remote control	Under 5N

### 23.2 Electrical data

Power supply	24V DC
Current	10 A
Protection class for electrical components	IPx9

# Operating Manual for ErGo OpTi Electrical Toilet, Bath and Hygiene Chair

## 24. Symbol Explanations

The following symbols are used on the labels and/or in these Instructions



Warning, see attached document.



User information



Class 2 equipment



Type B equipment (EN 60601-1)



For indoor use



Medical Equipment.



CE approval MDR (Medical Device Regulation) 2017/745

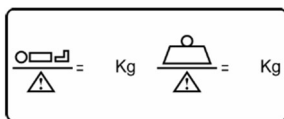

Safe Working Load (SWL) = Patient Max. Weight. + equipment



production address.



Production date.



Product item no.



Product serial no.



unique equipment identifier.

Product label (example).

	<p>Rehab Care Avnvej 10 7400 Herning Danmark</p>	<p>MAX LOAD: 250 kg</p>				
	<p>29-07-2024</p>	<p>POWER: 230V/24V5Amp</p>				
	<p>REF AKUT-14000</p>	<p>DUTY CYCLE: 10 %</p>				

10013  
 (01)05745000344130(11)240729(10)1005(21)10013

# Operating Manual for ErGo OpTi Electrical Toilet, Bath and Hygiene Chair

---

## Annex A Periodic inspection

**A.1** Periodic inspection of the chair should be undertaken as recommended by the manufacturer, at least once a year. Periodic inspection includes visual inspection, especially of the chair's support structure, hoist, brakes, steering, safety and personal aids, as well as a functionality test and any necessary maintenance, e.g. brake adjustment, tightening of screws, etc.

Every inspection must include a test of one (1) lift cycle with the maximum load.

**A.2** Periodic inspection must be undertaken by a suitably qualified person with knowledge of both the construction, use and maintenance of the chair.

**A.3** All observations and remarks should be noted in a logbook held by the person(s) responsible for servicing/maintenance of the chair.

The date when the chair is repaired according to any observations made under the inspection should also be noted in the logbook.

**A.4** The date when the inspection of the chair is undertaken, and the result of the inspection should be noted in the logbook together with the signature of the inspector.

**A.5** If the periodic inspection reveals faults, wear or other damage which constitutes a safety risk, the owner should be informed immediately. In the case of a direct safety risk the chair must be taken out of service immediately. The chair must not be used before it is repaired.

**A.6** Faults and serious damage which could constitute a safety risk, and which occur between inspections, but which have been corrected and repaired should also be noted in the logbook.

**A.7** Faults and damage should be reported to the manufacturer/dealer. This feedback should be noted in the logbook.

# Operating Manual for ErGo OpTi Electrical Toilet, Bath and Hygiene Chair

## Annex B Daily inspection before use

Nr.	Check	Remarks
1	<ul style="list-style-type: none"><li>All parts in place, no loose parts</li></ul>	
2	<ul style="list-style-type: none"><li>There are no defects in el-parts, actuator, cables</li></ul>	
3	<ul style="list-style-type: none"><li>There are no abnormal sounds from the actuator or steering box</li></ul>	
4	<ul style="list-style-type: none"><li>The chair has no rust or surface damage.</li></ul>	
5	<ul style="list-style-type: none"><li>The chair shows no sign of other damage.</li></ul>	
6	<ul style="list-style-type: none"><li>Wheels and wheel brake function</li></ul>	
7	<ul style="list-style-type: none"><li>A quick guide can be found on the chair</li></ul>	
8	<ul style="list-style-type: none"><li>Check battery charging indicator</li></ul>	

### Daily cleaning

Remove hair, soap and dirt around the wheels

Clean the chair with a damp cloth

The chair should be cleaned with cleaning or disinfectant fluid with a brush or sponge. Rinse, then dry thoroughly.

Harsh dissolvent must not be used.

100% chlorine solution must not be used.

When cleaning the wheels, cleaning fluids must not contain corrosive or damaging material



# Operating Manual for ErGo OpTi Electrical Toilet, Bath and Hygiene Chair

## Annex C Guidance, Yearly Inspection of chair

*(To be completed by the person responsible, with further control as deemed necessary)*

Date:		Product ID / serial nr.:
Carried out by:		
Inspection carried out at:		

Nr.	Check	Bemærkning
	<b>Visuel control of product</b>	
1	- Damage	
2	- Distortion	
3	- general damage	
4	- rust	
5	- stability – no loose parts	
6	- wheels run smoothly	
7	- loose wheels	
8	- check lift motor for wear	
Nr.	Check	Remarks
	<b>Lift motor/actuator/control box</b>	
9	- raise lift arm to maximum and ensure it stops	
10	actuator/lift motor must be replaced after 11.000 cycles. Piston rod on actuators must be lubricated	
11	Control of all functions for normal use: (tested with maximum load, a complete cycle. Should run smoothly and without noise)	
12	- check battery/charging indicator	
Nr.	Check	Remarks
	<b>Electrical parts/connections:</b>	
13	Check all cables are undamaged	
14	Check all cables are in place and cannot be trapped during use	
15	Check the cables and insulation for splits,	

# Operating Manual for ErGo OpTi Electrical Toilet, Bath and Hygiene Chair

16	Check all electrical parts that have legible labels	
Nr.	Check	Remarks
	<b>Additional:</b>	
17	Clean and grease as necessary	
18	Attach label with the date of the next inspection	

Date: \_\_\_\_\_ Initials/Signature \_\_\_\_\_

**The yearly inspection can be registered electronically in the product's service log with Rehab Care**

**Contact Rehab Care for further information**

# Operating Manual for ErGo OpTi Electrical Toilet, Bath and Hygiene Chair

## Annex D Drawing

### D1. Drawing - ErGo OpTi

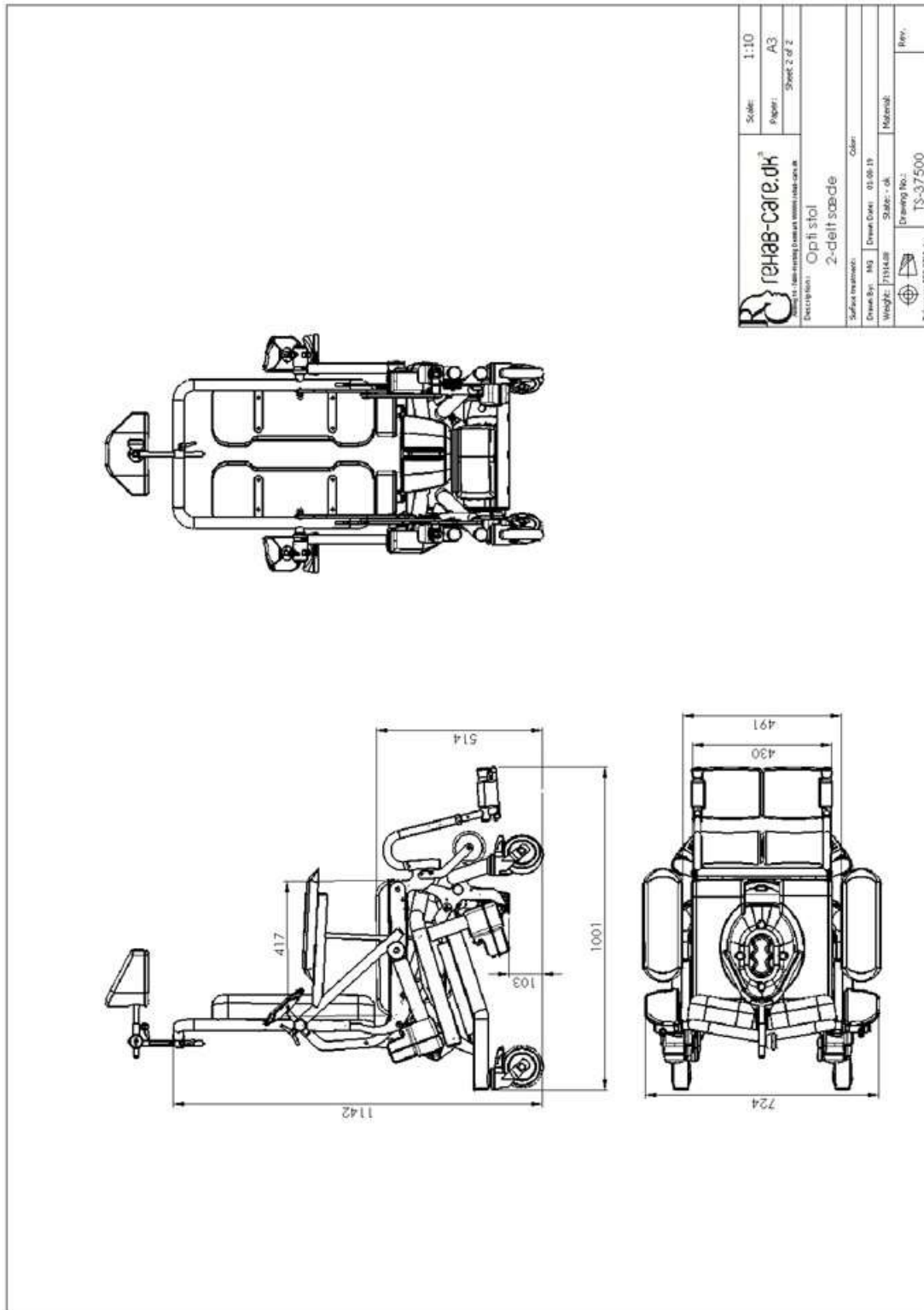



# Operating Manual for ErGo OpTi Electrical Toilet, Bath and Hygiene Chair

## Annex F Troubleshooting

Nr.	Fault	Possible cause	Solution
1	Function failure	Is the power switched on?	Switch on
2	Function failure	Is the battery fully charged?	If no – charge battery If yes – check all connections
3	Function failure	Are all plugs correctly connected?	Press plugs firmly
4	Function failure	Are there visible splits/damage to the cable?	Replace cable
5	Function failure	Is the emergency button activated (pressed in)?	Reset emergency button – press 3 secs.
6	Function failure	Battery cannot be charged	Battery can be defective – contact dealer

Contact the dealer if the chair does not function correctly.

## Annex G EMC Form.

Rehab Care products are intended for use in the electromagnetic environment specified below.

**Table 1: Manufacturer's Declaration – Electromagnetic Emissions**

Emissions Tests	Compliance	Electromagnetic Environment
RF emissions CISPR 11	Group 1	The products use RF energy only for its internal function. Therefore, its RF emissions are very low and are not likely to cause any interference in nearby electronic equipment.
RF emissions CISPR 11	Class B	The products is suitable for use in all establishments, including domestic establishments and those directly connected to the public low-voltage power supply network that supplies buildings used for domestic purposes.
Harmonic emissions IEC 61000-3-2	Class A	
Voltage fluctuations/ flicker emissions IEC 61000-3-3	Complies	

# Operating Manual for ErGo OpTi Electrical Toilet, Bath and Hygiene Chair

**Table 2: Manufacturer's Declaration – Electromagnetic Immunity**

Immunity tests	IEC 60601 Test Level	Compliance Level	Electromagnetic Environment
Electrostatic discharge (ESD) IEC 61000-4-2	±8 kV contact ±15 kV air	±8 kV contact ±15 kV air	Floors should be wood, concrete or ceramic tile. If floors are covered with synthetic material, the relative humidity should be at least 30 %.
Electrical fast transient/burst IEC 61000-4-4	±2 kV for mains ±1 kV for signal lines	±2 kV for mains ±1 kV for signal lines	Mains power quality should be that of a typical commercial or hospital environment.
Surge IEC 61000-4-5	±1 kV line(s) to lines(s) ±2 kV line(s) to earth	±1 kV line(s) to lines(s) ±2 kV line(s) to earth	Mains power quality should be that of a typical commercial or hospital environment.
Voltage dips, short interruptions and voltage variations on power supply input lines IEC 61000-4-11	<5% $U_T$ (>95% dip in $U_T$ ) for 0.5 cycle  <5% $U_T$ (>95% dip in $U_T$ ) for 1 cycle  70% $U_T$ (30% dip in $U_T$ ) for 25/30 cycles  <0% $U_T$ (100% interruption in $U_T$ ) for 5 sec	<5% $U_T$ (>95% dip in $U_T$ ) for 0.5 cycle  <5% $U_T$ (>95% dip in $U_T$ ) for 1 cycle  70% $U_T$ (30% dip in $U_T$ ) for 25/30 cycles  <0% $U_T$ (100% interruption in $U_T$ ) for 5 sec	Mains power quality should be that of a typical commercial or hospital environment. If the user of the products requires continued operation during power mains interruptions, it is recommended that the products be powered from an uninterruptible power supply or a battery.
Power frequency magnetic field IEC 61000-4-8	30 A/m	30 A/m	Power frequency magnetic fields should be at levels characteristic of a typical location in a typical commercial or hospital environment.

NOTE 1:  $U_T$  is the AC mains voltage prior to application of the test level

Portable and mobile RF communications equipment should be used no closer to any part of the product, including cables, than the recommended separation distance calculated from the equation applicable to the frequency of the transmitter.

# Operating Manual for ErGo OpTi Electrical Toilet, Bath and Hygiene Chair

**Table 3: Manufacturer's Declaration – Electromagnetic Immunity (continued)**

Immunity tests	IEC 60601 Test Level	Compliance Level	Electromagnetic Environment
Conducted RF IEC 61000-4-6  outside the ISM bands <sup>a</sup> and amateur radio bands	3 Vrms 150 kHz to 80MHz	3 Vrms	<b>Recommended separation distance</b>  $d = [3.5 / V_1] \sqrt{P}$
Conducted RF IEC 61000-4-6  inside the ISM bands <sup>a</sup> and amateur radio bands	6 Vrms 150 kHz to 80MHz	6 Vrms	<b>Recommended separation distance</b>  $d = [12 / V_2] \sqrt{P}$
Radiated RF IEC 61000-4-3	10 V/m 80MHz to 2.7 GHz	10 V/m	$d = [12 / E_1] \sqrt{P}$ 80 MHz to 800 MHz $d = [23 / E_1] \sqrt{P}$ 800 MHz to 2.7 GHz  where $P$ is the maximum output power rating of the transmitter in watts (W) according to the transmitter manufacturer and $d$ is the recommended separation distance in metres (m).

Field strengths from fixed RF transmitters, as determined by an electromagnetic site survey <sup>d</sup> should be less than the compliance level in each frequency range <sup>e</sup>.

Interference may occur in the vicinity of equipment marked with the following symbol:



NOTE 1: At 80 MHz to 800 MHz, the higher frequency range applies.

NOTE 2: These guidelines may not apply in all situations. Electromagnetic propagation is affected by absorption and reflection from structures, objects and people.

- a) The ISM (industrial, scientific and medical) bands between 150 kHz and 80 MHz are 6.765 MHz to 6.795 MHz; 13.553 MHz to 13.567 MHz; 26.957 MHz to 27.283 MHz; and 40.66 MHz to 40.70 MHz.
- b) The amateur radio bands between 150 kHz and 80 MHz are 1.8 MHz to 2.0 MHz. 3.5 MHz to 4.0 MHz. 5.3 MHz to 5.4 MHz. 7 MHz to 7.3 MHz. 10.1 MHz to 10.15 MHz. 14 MHz to 14.2 MHz. 18.07 MHz to 18.17 MHz. 21.0 MHz to 21.4 MHz. 24.89 MHz to 24.99 MHz. 28.0 MHz to 29.7 MHz and 50.0 MHz to 54.0 MHz
- c) The compliance levels in the ISM frequency bands and the amateur radio frequency bands between 150 kHz and 80 MHz and in the frequency range 80 MHz to 2.7 GHz are intended to decrease the likelihood that mobile/portable communications equipment could cause interference if it is inadvertently brought into patient areas. For this reason, an additional factor of 10/3 is used in calculating the recommended separation distance for transmitters in these frequency ranges.
- d) Field strengths from fixed transmitters, such as base stations for radio (cellular/cordless) telephones and land mobile radios, amateur radio, AM and FM radio broadcast and TV broadcast cannot be predicted theoretically with accuracy. To assess the electromagnetic environment due to fixed RF transmitters, an electromagnetic site survey should be considered. If the measured field strength in the location in which the equipment is used exceeds the applicable RF compliance level above, the equipment should be

# Operating Manual for ErGo OpTi Electrical Toilet, Bath and Hygiene Chair

observed to verify normal operation. If abnormal performance is observed, additional measures may be necessary, such as reorienting or relocating the equipment.

e) Over the frequency range 150 kHz to 80 MHz, field strengths should be less than 10 V/m.

Rehab Care products are intended for use in an electromagnetic environment in which radiated RF disturbances are controlled. The customer or the user of the products can help prevent electromagnetic interference by maintaining a minimum distance between portable and mobile RF communications equipment (transmitters) and the products as recommended below, according to the maximum output power of the communications equipment.

**Table 3: Recommended separation distances between portable and mobile RF communications equipment and the products.**

Radio Service	Frequency band [MHz]	Maximum Power [W]	Separation Distance [m]	Tested immunity Level [V/m]
TETRA 400	380-390	1.8	0.3	27
GMRS 460 FRS 460	430-470	2	0.3	28
LTE Band 13/17	704-787	0.2	0.3	9
GSM 800/900 TETRA 800 iDEN 820 CDMA 850 LTE Band 5	800-960	2	0.3	28
GSM 1800/1900 CDMA 1900 UMTS DECT LTE Band 1/3/4/25	1700-1990	2	0.3	28
Bluetooth WLAN 802.11 b/g/n RFID 2450 LTE Band 7	2400-2570	2	0.3	28
WLAN 802.11 a/n	5100-5800	0.2	0.3	9

For transmitters rated at a maximum output power not listed above, the recommended separation distance  $d$  in metres (m) can be determined using the equation applicable to the frequency of the transmitter, where  $P$  is the maximum output power rating of the transmitter in watts (W) according to the transmitter manufacturer.

NOTE 1 At 80 MHz and 800 MHz, the separation distance for the higher frequency range applies.

NOTE 2 The ISM (industrial, scientific and medical) bands between 150 kHz and 80 MHz are 6,765 MHz to 6,795 MHz; 13,553 MHz to 13,567 MHz; 26,957 MHz to 27,283 MHz; and 40,66 MHz to 40,70 MHz.

NOTE 3 An additional factor of 10/3 is used in calculating the recommended separation distance for transmitters in the ISM frequency bands between 150 kHz and 80 MHz and in the frequency range 80 MHz to 2,5 GHz to decrease the likelihood that mobile/portable communications equipment could cause interference if it is inadvertently brought into patient areas.

NOTE 4 These guidelines may not apply in all situations. Electromagnetic propagation is affected by absorption and reflection from structures, objects and people.