

Manual Cathy Patient Lift / Mobile stand up Lift

03-2017



ISO 13485
Management System Certification

BUREAU VERITAS
Certification Denmark A/S



Manual

Cathy Patient Lift / Mobile stand up Lift

03-2017

Contents

1. Introduction	3
2. Unpacking	3
3. General Security Rules	4
4. Area of Use	5
5. Use of Lift	5
6. Products Life Expectancy	6
7. Equipment and Accessories	6
8. Power connection	6
9. Battery charging	7
10. Changing the batteries	8
11. Electrical operating procedure	8
12. Brakes	9
13. Emergency stop / Emergency lowering	9
14. Types of sling / Hangbar	10
15. Transfer handling instructions	11
16. Handling of parts during Transport	11
17. Cleaning	12
18. Maintenance	12
19. Service	12
20. Transport and Storage	13
21. Disposal	13
22. Electromagnetic – EMC influence	14
23. Guarantee	14
24. Technical data	15
25. Symbols	16
Annex A Periodic inspection	17
Annex B Recommended daily inspection before use	18
Annex C Recommended annual service inspection	19
Annex D Drawings	21
Annex E Spare Parts	22
Annex F Troubleshooting	24

Manual

Cathy Patient Lift / Mobile stand up Lift

03-2017

1. Introduction

Congratulations on your new Rehab-Care.dk equipment.

Rehab-Care.dk products are modern and up-to-date, based on our long experience in this field.

This equipment brings functionality, quality and ease of handling up to an optimal level.

Through continuous development at all levels of our manufacturing process, we are committed to pay attention to detail and quality. We are therefore your guarantee of a very reliable and functional product.

The Cathy Patient Lift complies with the medial directives for class 1 equipment (Medical Devices Regulation (EU) 2017/745 - MDR), EN 60601-1: 2015, EN60601-1-2: 2015, ISO 10535: 2006.

Thank you for your confidence in our product, and for your cooperation.

We wish you every satisfaction with your new equipment.

Best regards Rehab-Care dk ApS.

Version 03-08.02.2017

Manufactured by:



Rehab- Care.dk ApS
Avnvej 10
7400 Herning, DK

Agent:

2. Unpacking

Unpack the lift carefully and check all parts and accessories.

Check for possible transport damage.

We recommend that the lift is cleaned before use, see cleaning instructions.













Contact dealer if the equipment is damaged or not functioning.

Manual

Cathy Patient Lift / Mobile stand up Lift

03-2017

3. General Security Rules

-  Warning! Do not use a high pressure cleaner on this product.
-  Warning! Do not use chemicals. Carry out an annual inspection for damage.
-  Warning! Use only the supplied remote control.
-  Warning! Prevent foreign articles from damaging the wheels.
-  Warning! Use only spare wheels recommended by the supplier.
-  Warning! Children must not use the lift without supervision, it is not a toy.
-  Warning! The Cathy lift has a maximum capacity of **200 kg**.
-  Warning! Use only the approved sling.
-  Warning! Before and during the lift, ensure that operating personnel and the patient remain clear of all moving parts.
-  Warning! The lift should not be used if there is any doubt about it being in good working order.
-  Warning! Do not lift the patient higher than necessary.
-  Warning! The Cathy lift is not a means of transport, therefore transport of a patient should be restricted as much as possible.
-  Warning! The Cathy lift could overturn with improper use. Ignoring security rules and instructions for use could lead to accident.

NOTICE! Before use

To avoid any damage during handling and use, this manual should be read and understood. Before use follow the checklist at the end of this manual.

Manual

Cathy Patient Lift / Mobile stand up Lift

03-2017

4. Area of Use

The Cathy Lift is for use in the following situations:

1. Lift from bed to chair/wheelchair next to the bed.
2. Lift from wheelchair to toilet or bath chair.
3. In care/nursing areas where at least one person is qualified to use the lift, or where a responsible person is present.
4. The lift must not be used for any other than the approved purpose.
5. Use only the approved sling with the lift.

The lift is for indoor use only.

The lift safe working load (SWL) is as follows:

SWL: 200 kg.

Persons with physical or psychological handicaps must not use the product without supervision or without adequate training in the use of the lift.

Children must not be left unsupervised around the lift, it is not a toy.



Warning!

The Cathy Lift has a maximum capacity of **200 kg**.

5. Use of Lift

- The Cathy lift is constructed for most normal lift situations, e.g. transfer to and from the toilet, between bed and wheelchair, and stand up function.
- Before a patient is lifted with the equipment, the operator must be familiar with all general and security instructions for use.
- The operator should test the equipment, including the sling, together with a colleague before attempting to lift a patient.
- The operator should explain the lifting procedure in detail when introducing the patient to the equipment for the first time.
- The operator is responsible for any defects in the lift, therefore visual control before use is mandatory.
- Persons with physical or psychological handicaps must not use the product without supervision or without adequate training in the use of the lift.
- Children should be supervised to ensure that they do not play with the product.
- Any malfunction should be reported to the dealer immediately.
- Ensure that the brakes are released before moving the equipment.

Manual

Cathy Patient Lift / Mobile stand up Lift

03-2017

6. Products Life Expectancy

In accordance with EN/ISO 10535 "Hoist for the transfer of disabled persons – requirements and test methods", an annual service and security check must be carried out by qualified personnel.

The product has a life expectancy of 15 years, based on correct use, service and maintenance. If the lift is to be used after the 15-year life expectancy, it must be evaluated by qualified service personnel before further use.

It is the operator's responsibility to ensure regular evaluation of the lift after 15 years.

Electrical parts must only be serviced by a qualified technician.

7. Equipment and Accessories

The lift consists of:

- Frame on 4 wheels
- Electrical adjustment by remote control
- Electrical angling of device feet
- Emergency lowering
- Emergency stop
- Battery function
- Removable battery

Extra accessories available:

- Changing from hook to knob system.
- Extra jumbo battery
- Wall-charger for jumbo batter

8. Power connection

The lift is connected to 230V by plugging the transformer into the power supply.

The lift does not have to be connected 230V for use as the lift is equipped with battery.

When the charger is not in use, the cord is wrap up and stored in a dry and safe place.



Warning! Before connection, control the cable for damage

Manual

Cathy Patient Lift / Mobile stand up Lift

03-2017

9. Battery charging

To ensure the longest possible battery life. Batteries should be charged before use. Charging time depends on the condition of the batteries.

Before using the lift for the first time, batteries should be charged for **24 hours** to ensure they are fully charged and give the longest possible battery life.

Batteries need regular charging, and it is recommended they be charged every night.

Be aware that the emergency stop must not be activated during battery charging.



If the recharge indicator lights up, the batteries must be recharged.



The lift's batteries can be charged in two ways:

-
- Connect the supplied net cable with the plug under the control box.
- Disconnect the batteries and connect to an external charger (extra accessory).



There are three indicator lights on the control box.

1. The left light shows green when the net cable is connected.
2. The light shows yellow when charging..

If the indicator does not light up, contact your dealer or RehabCare.dk.



ATTENTION!

If the lift has been stored for more than 6 months after manufacture, batteries require charging every 6 months..



Warning!
Lift must not be used during recharging!



Warning!
Batteries must not be charged in a wet room, bathroom, or similar!

Manual

Cathy Patient Lift / Mobile stand up Lift

03-2017

10. Changing the batteries





If the lift is not working normally and the batteries are fully charged, it can mean that the batteries' lifetime is over and they need to be changed.

Changing the batteries must only be carried out by qualified personnel.
Use only original spare parts.

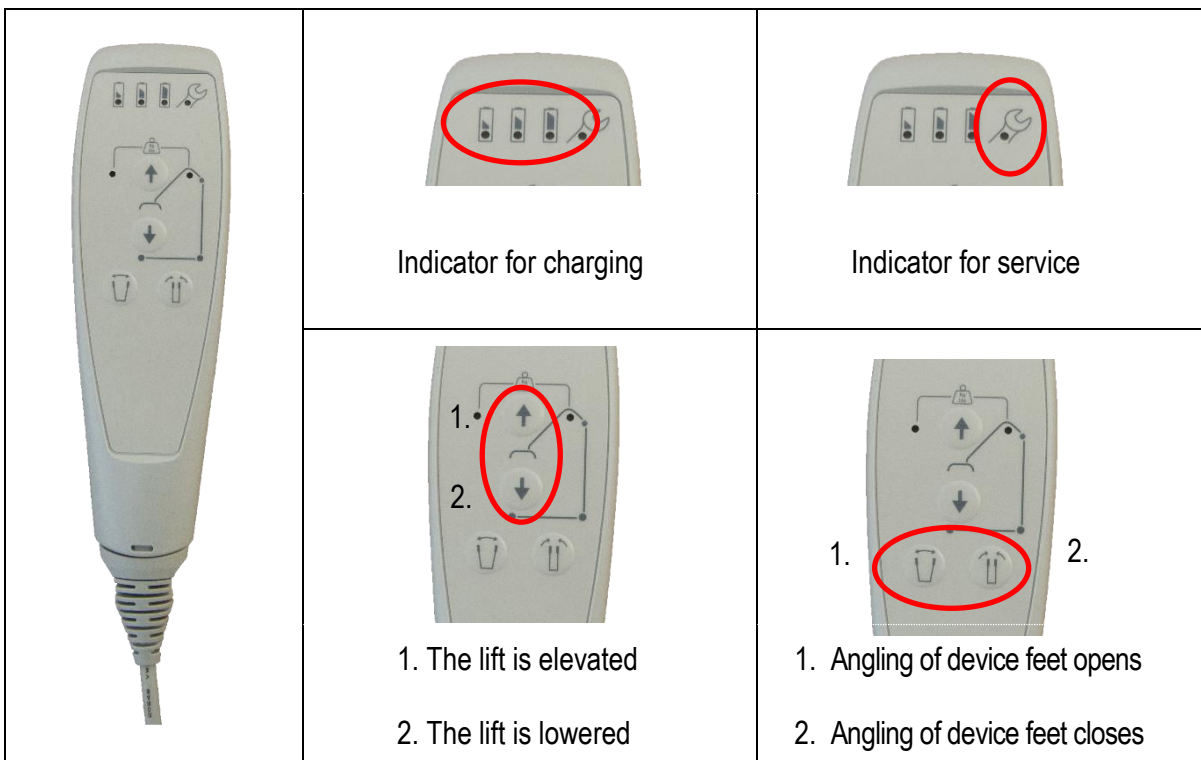
11. Electrical operating procedure

Remote controle



-  When lifting a patient, the maximum weight must not be exceeded
-  When lifting, SWL must not be exceeded
-  Check there is a free space over the lift before lifting
-  The lift must be able to function unhindered up and down
-  Check the remote control cable is in good condition and free from any damage

Manual



Cathy Patient Lift / Mobile stand up Lift

03-2017

12. Brakes

<p>Brakes</p> 	<p>The rear wheel has brakes. Brakes are activated by pressing the brake pedal down. Brakes should always be on when the lift is parked.</p>
--	--

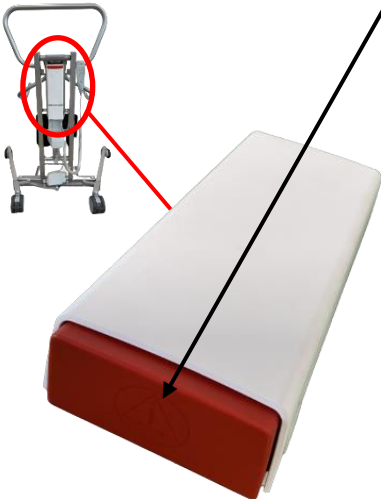
13. Emergency stop / Emergency lowering

<p>Emergency stop / Emergency lowering</p> 	<p>Emergency stop Regularly control that the emergency stop is working correctly. The lift must not be used if the emergency stop button is not working.</p> <p>When the emergency stop button and pushed the lift should stop immediately.</p> <p>The emergency stop button is released after use by pressing the 2 buttons at the side, then put the battery back, and hereafter the lift is ready for use again. The emergency stop must not be used as a start/stop button.</p>
<p>Emergency lowering</p> 	<p>Emergency lowering The lift has a mechanical lowering function. When the ring on the lift's actuator is pulled upwards, the lift arm moves down, activated by the patient's weight.</p>

Manual

Cathy Patient Lift / Mobile stand up Lift

03-2017

14. Types of sling / Hangbar

Types of slings must be CE approved Rehab Care Sling: Stand Up sling with belt.

Slings must be designed for use with hook / knob

Hook



Knob



Manual

Cathy Patient Lift / Mobile stand up Lift

03-2017

15. Transfer handling instructions

1. The leg-angle of the lift must be widened before lifting a patient. They must only be parallel when the lift is parked.
2. The remote control allows the operator to be closer to the patient, thereby creating a feeling of security.
3. The lift should be pulled during transfer as this causes the least movement and discomfort for the patient as well as the least strain on the operator. The lift should only be pushed to place it over the bed.
4. To turn the lift the operator should stand at the side of the lift. The lift will turn on its own centre gravity by the operator pulling with one hand on one of the lift's handles, and pushing the sling with the other hand.
5. To move the lift, it is recommended that the operator uses the whole body and does not twist the torso or shoulder.
6. During transfer make sure the lift moves smoothly and with stability. Be aware of any obstacles in its passage.
7. Only turn the lift by means of the handle, otherwise it could cause the patient to sway in the sling.
8. Work carefully, prepare the lift, move the wheelchair close to the lift.
9. Move the lift slowly, quick movements are unpleasant for the patient and could present a security hazard.
10. Pull the lift when passing doorsteps or other obstacles, this creates a softer and more secure movement.
11. Do not try to lift the Cathy Lift. This is dangerous for both operator and patient.
12. Do not use brakes when the patient is lowered to a sitting position.
13. Do not lift the patient higher than necessary.
14. The lift is not a means of transport.



Warning!

The lift can shift by wrong use!

Failure to respect the warnings and instructions can lead to injuries.

Read the instructions carefully before attempting to lift anyone.

16. Handling of parts during Transport

Lift Tower and wheel frame.

Manual

Cathy Patient Lift / Mobile stand up Lift

03-2017

17. Cleaning

The actuator and control box must only be cleaned with a damp cloth.

Metal parts can be cleaned with cleaning or disinfectant products.

Wheels must only be cleaned with products which do not contain corrosive or damaging materials.



Warning! Never use a high pressure spray on the lift.



Warning! Steam cleaning must not be used.



Warning! Must not be machine washed.



Warning! In order to avoid injury, the emergency-stop should be activated in (all) transport and cleaning situations.

18. Maintenance

Wheels should be kept free of hair and dirt.

Annual service is recommended.

Moving parts should be checked, tightened and greased.

Worn bearings should be replaced, at turning points.

Batteries should be replaced as necessary.

19. Service

It is recommended that the Mary lift has an annual service performed by qualified personnel. This annual service is also recommended in standard EN ISO 10535. It is the lift's owner's responsibility to ensure that the annual service is carried out. The service should be logged in the protocol for each lift and undersigned by the client after each inspection.

Should the technician discover a serious fault in the equipment; it is his duty to withdraw the equipment from use if the fault could lead to a security risk.

All service, repairs and other additional work on the equipment between the annual inspections must be noted in the service protocol.

Manual

Cathy Patient Lift / Mobile stand up Lift

03-2017

19.1 Service – CONTROL BOX

As a rule, the control box should be serviced on a 12 monthly/8000-cycle basis, Whichever comes first.

A light diode in the front of the control box will light up when service is due.

The control box starts counting from the day of production.

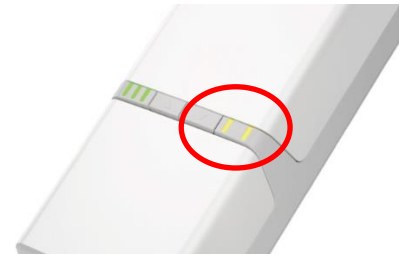

19.2 Service – ACTUATORER

The actuator/lift motor should be changed after 11,000 cycles or at least every 5 years.

Changing the actuator must only be carried out by authorised service personnel.

19.3 Service – WHEEL

Wheels should be serviced when necessary: Tightening of bolts.

Wheels have closed and dust sealed bearings, lubrication is not necessary.

Cleaning products containing corrosive or damaging materials must not be used.

Wheels and frame parts should be replaced when not operating properly.

20. Transport and Storage

If the lift is not to be used for a long period, it is recommended that it be covered to protect it from dirt and dust. The battery should also be removed, as the lifetime of the battery is significantly reduced if fully discharged.

The lift should be stored in a frost-free environment with humidity of not exceeding 80%.

Transport and storage requirements:

- Humidity between 10 and 80%
- Temperature between -30 and 40 deg. C
- Pressure between 700 – 1100 hPa

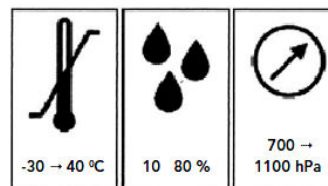

21. Disposal

For disposal, the lift must be taken apart and separated into electronic and metal waste respectively. Dispose of items according to local regulations. Must not be disposed with household waste.

Manual

Cathy Patient Lift / Mobile stand up Lift

03-2017

22. Electromagnetic – EMC influence

- Portable and mobile RF communication equipment (for example cell phones) can influence electronic medical equipment, and should be kept at a distance of at least **35cm.** from the medical equipment.
- Use of other than the specified accessories and cables can result in higher emissions or reduce the unit's immunity. Use of unauthorized cable and accessories can negatively influence EMC efficiency.
- Electrical parts: Steering, motor and cable details can be found in the spare-parts list belonging to the product.
- Mains-supply electricity should be of the normal quality found in industrial and hospital environments.
- Correct maintenance is important to uphold EMC requirements.
- In the event of EMC noise from the product, contact the manufacturer.
- Other conditions concerning EMC: None.

23. Guarantee

In accordance with Danish law, the lift has a 2-year guarantee.

The guarantee becomes null and void in the following circumstances:

1. Overloading the lift.
2. Violent use of lift.
3. Operating error, wrong use of lift.
4. Lack of or wrong maintenance.
5. If the LINAK electrical parts are opened or have been wrongly used.

For complaints: Please provide serial number. This can be found on the product label, located at the wheel frame.

At Rehab-Care dk ApS we endeavor to continually improve our products.

We reserve the right to improve the product without prior notice.

All measurements on drawings or other material are only guidelines with the usual provisions for errors.

Manual

Cathy Patient Lift / Mobile stand up Lift

03-2017

24. Technical data

24.1 Weights and Measures

Max. Load	200 kg
Lift interval	77 cm - 171 cm.
Number of lifts with 100 kg	ca. 70 lifts.
Outer width frame	65 cm.
Inner width frame	59 cm.
Frame height	12 cm.
Frame length	94 cm.
Wheel diameter	Ø105 mm
Turning radius	ca.135 cm.
Total weight	50 kg
Frame weight	25 kg.
Noise level	Under 50 dB
Surface cover	powder coated steel
RAL colour standard	RAL9006
Actuation force for activating hand control	Under 5N

24.2 Electrical data

Power	24V DC
Current	10 A
Protection class	IPx4
See description of CBJ control box	

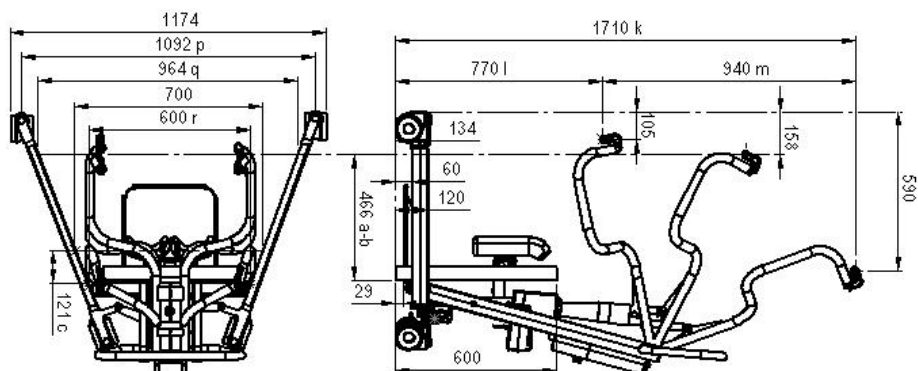

Manual

Cathy Patient Lift / Mobile stand up Lift

03-2017

25. Symbols

The following symbols are used on labels and in this manual:



Warning



User information

IPX6

Humidity protection: Can resist high pressures of water



Class 2 equipment



Type B equipment (EN 60601-1)



For indoor use



CE approved directive for medical equipment 93/42/EC

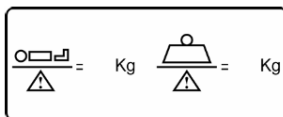
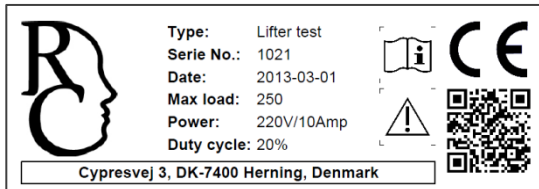

Safe Working Load (SWL)
Patient max weight



Do not twist the actuator

Manual

Cathy Patient Lift / Mobile stand up Lift

03-2017

Annex A Periodic inspection

Periodic inspection

A.1 Periodic inspections should be carried out according to the time frame recommended by the manufacturer, or at least once a year. The periodic inspection comprises a visual inspection, especially of the wheelbase structure, hoist mechanism, brakes, turning points, security devices and patient aids, as well as a function test and normal maintenance, e.g. brake adjustment, tightening of screws, etc.

Each inspection must include one (1) lift with maximum load.

A.2 Periodic inspection must be carried by a suitably qualified person with knowledge of the construction, use and maintenance of the equipment..

A.3 All important security observations must be entered in a logbook to be kept by the person(s) responsible for servicing/maintenance of the lift.
The date measures are taken in reaction to the observations should also be noted in the logbook..

A.4 Date and result of the inspection should be entered in the logbook and signed by the inspector.

A.5 In case of fault, wear or other damage that threatens the security of the lift, the owner should be informed immediately. In the case of evident security risk, the lift should be withdrawn from use immediately. The lift must not be used until the fault is rectified.

A.6 Any damage threatening security of the lift that occurs between inspections and which has already been corrected should be entered in the logbook.

A.7 Faults and damage should be reported to the manufacturer/dealer. This feedback must be entered in the logbook.

Manual

Cathy Patient Lift / Mobile stand up Lift

03-2017

Annex B Recommended daily inspection before use

No.	Check	Remarks
1	<ul style="list-style-type: none">All parts are in place, no loose parts.	
2	<ul style="list-style-type: none">No defective electrical parts, actuator, cables.	
3	<ul style="list-style-type: none">No abnormal sounds from actuator or control box	
4	<ul style="list-style-type: none">No rust or surface damage.	
5	<ul style="list-style-type: none">No other visual damage	
6	<ul style="list-style-type: none">Wheel and wheel brake system	
7	<ul style="list-style-type: none">Quick guide to be found with lift	
8	<ul style="list-style-type: none">Sling is CE approved	
9	<ul style="list-style-type: none">Battery charge indicator	

Daily cleaning

Remove hair and dust around the wheels.

Clean lift with a damp cloth.

Clarification:

The lift should be cleaned with cleaning or disinfection liquid, using a brush or sponge, and thereafter washed. Dry thoroughly after wash.

Concentrated disinfection liquid must not be used.

100% chlorine solution must not be used.

Automatic wash machines must not be used.

For cleaning of wheels, corrosion-free liquid must be used.



Warning!
High pressure cleaner must not be used



Warning!
Steam cleaning must not be used



Warning!
Machine wash must not be used

Manual

Cathy Patient Lift / Mobile stand up Lift

03-2017

Annex C Recommended annual service inspection

(Complete/adapt as appropriate)

Date:		Product ID / serial no.
Carried out by:		
Service by:		

No.	Check	Remarks
	Visual control of product	
1	- wear	
2	- distortion	
3	- general damage	
4	- rust	
5	- stability – no loose parts	
6	- wheels run easily	
7	- wheel brakes function	
8	- wear of lift hooks	
9	- connection between hook and sling	
	Actuator / controlbox	
10	- test top stop position	
11	- Actuator needs replacing after 11,000 lifts or at least every 5 years	
12	- Control all functions in normal use (one full cycle with maximum load, no problems or abnormal sounds)	
13	- Control emergency down	
14	- Control emergency stop	
15	- Control battery charge indicator	
	The standard setting is after 12 months/8000 cycles (whichever comes first).	

Manual

Cathy Patient Lift / Mobile stand up Lift

03-2017

No.	Check	Remarks
	Electrical parts /connections	
16	Check all cables	
17	Check all cables are fixed and secure	
18	Check all cables are split-free	
19	Check all labels on electrical parts are legible	
	Other :	
20	Clean and lubricate as necessary	
21	Place label with date for next inspection	
22		
23		

Date: _____ Initials/signature: _____

The annual inspection can be registered electronically in the product service log at Rehab-Care.dk.

Please contact Rehab-Care.dk for further information.

Manual

Cathy Patient Lift / Mobile stand up Lift

03-2017

Annex D Drawings

D1. Drawing – Cathy Patient Lift

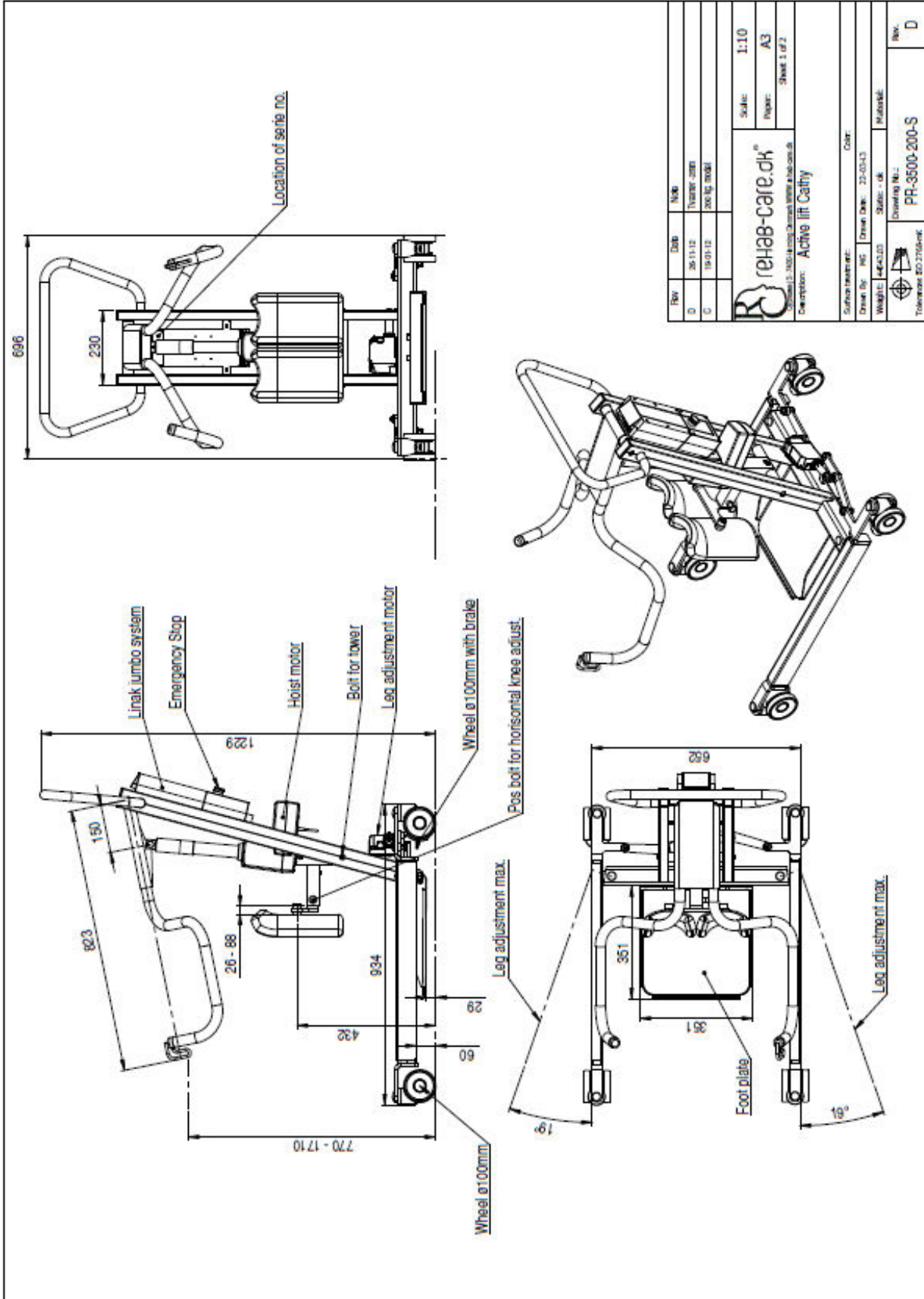

Manual

Cathy Patient Lift / Mobile stand up Lift

02 2017

Annex E Spare Parts

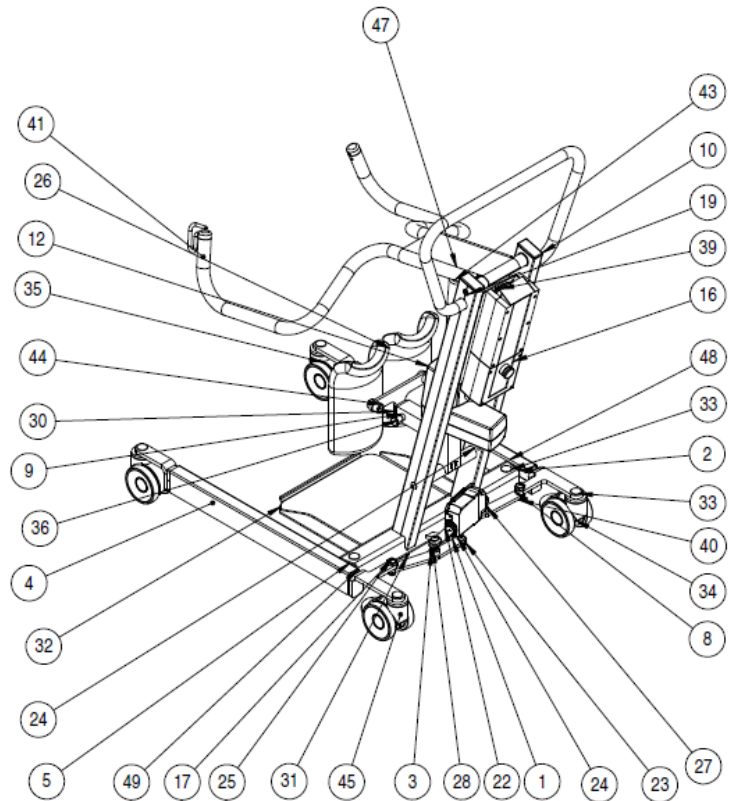

Drawing ID : PR-3500-200-S (rev.D)

No.	PART NUMBER	DESCRIPTION	QTY.
1	PR-2000	Tower mount	1
2	PR-1500-S	Leg righth	1
3	PR-3100	Trækstang for ben-V	1
4	PR-1000-S	Leg left	1
5	PAF 2825115 P10	Kravebøsning $\phi 28/25-11\text{mm}$	6
6	PR-3004	Aksel for ben	2
7	PR-3005	Distance ring for legs	2
8	PAF 15090 P10	Kravebøsning $\phi 17/15-9\text{mm}$	2
9	PR-4000-S	Tower for stand up lift	1
10	60X30 PROP		2
11	PR-5004	Aksel til løftearm	1
12	LA34-200-02 bund	Linak act. LA34-200mm	1
13	PAF 14090 P10	Kravebøsning $\phi 14/12-9\text{mm}$	3
14	AF-12-10,5	Afstandsring $\phi 12 \times 10,5$	3
15	Pin- $\phi 10-$	Pin- $\phi 10-47$	1

No.	PART NUMBER	DESCRIPTION
26	PU-B-295-S	Kneepad
27	PR-3000	Trækstang for ben-H
28	Hexagon Thin Nut ISO 4035 - M10 - N	
29	Circlip DIN 471 - 10 x 1	
30	PR-4500-S	Holder for knee supp.
31	PR-6000-S	Foot plate frame
32	PR-6008-S	Foot plate alu.
33	ISO 8678-M12x80-30-N 6	
34	Prevailing torque type hexagon nut ISO 7040 - M12	
35	5940UAP100P30-11	Tente wheel $\phi 100$
36	ZS-12x1-75	Pos bolt for adjust
37	ISO 4029 - M6 x 8 - N	
38	Sticker	CE-mark and serie no
39	Hexagon socket head cap screw DIN 912 - M5 x 12	
40	DIN EN ISO 7040 -	

Manual

Cathy Patient Lift / Mobile stand up Lift

03-2017

	47		
16	Jumbo	CBJ styring	1
17	PR-1006	Leg adjustm nut-12mm	2
18	PR-1010	Leg adjustm nut-3mm	2
19	DIN 912 M10 x 35 --- 35N		2
20	Hexagon socket head cap screw DIN 912 - M8 x 12		2
21	PR-1008	Afstandsør	2
22	LA23- bund- 50mm	LA23-50 akt	1
23	PR-3007	Gear plate for legs	1
24	Hexagon socket button head screw ISO 7380 - M10 x 20		5
25	Hexagon socket button head screw ISO 7380 - M10 x 40		4

	M10 - N	
41	PR-5600-S	Lifting arm
42	Pin-ø10-42-star	Pin for atc top
43	STAR-LOCK	
44	DIN 912 M16 x 25 - -- 25N	
45	5947UAP100P30- 11-kick-p	Wheel with brake
46	Nut DIN 1587 - M5	
47	PR-9100-S	
48	PR-9101-S	Skærm for ben højre
49	PR-9102-S	Skærm for ben venstre

Manual

Cathy Patient Lift / Mobile stand up Lift

03-2017

Annex F Troubleshooting

No.	Fault	Possible cause	Solution
1	Malfunction	Is is switched on?	Switch on
2	Malfunction	Is the battery fully charged?	If no – charge the battery If yes – check all connections
3	Malfunction	Are all plugs properly connected?	Press hard to connect plug
4	Malfunction	Are there visible breaks in/damage to the cable?	Replace cable
5	Malfunction	Is the emergency stop activated? (pressed in)	De-activate the stop button. Emergency stop button can be released after use by twisting it a quarter-turn.
6	Malfunction	Can the battery not be charged?	Battery can be defective – contact the dealer.

Contact the dealer if the equipment is out of order.

Do not use defective equipment..